

GREAT Kitchens

On a Budget™

**DREAM
UPDATES
FOR LESS**

BEST & WORST

- REFRIGERATORS
- RANGES
- COOKTOPS
- DISHWASHERS
- MICROWAVES
- WALL OVENS
- COUNTERTOPS
- FLOORING

**APPLIANCE
SHOPPING**
WHERE TO FIND
BIG SAVINGS



CONTENTS



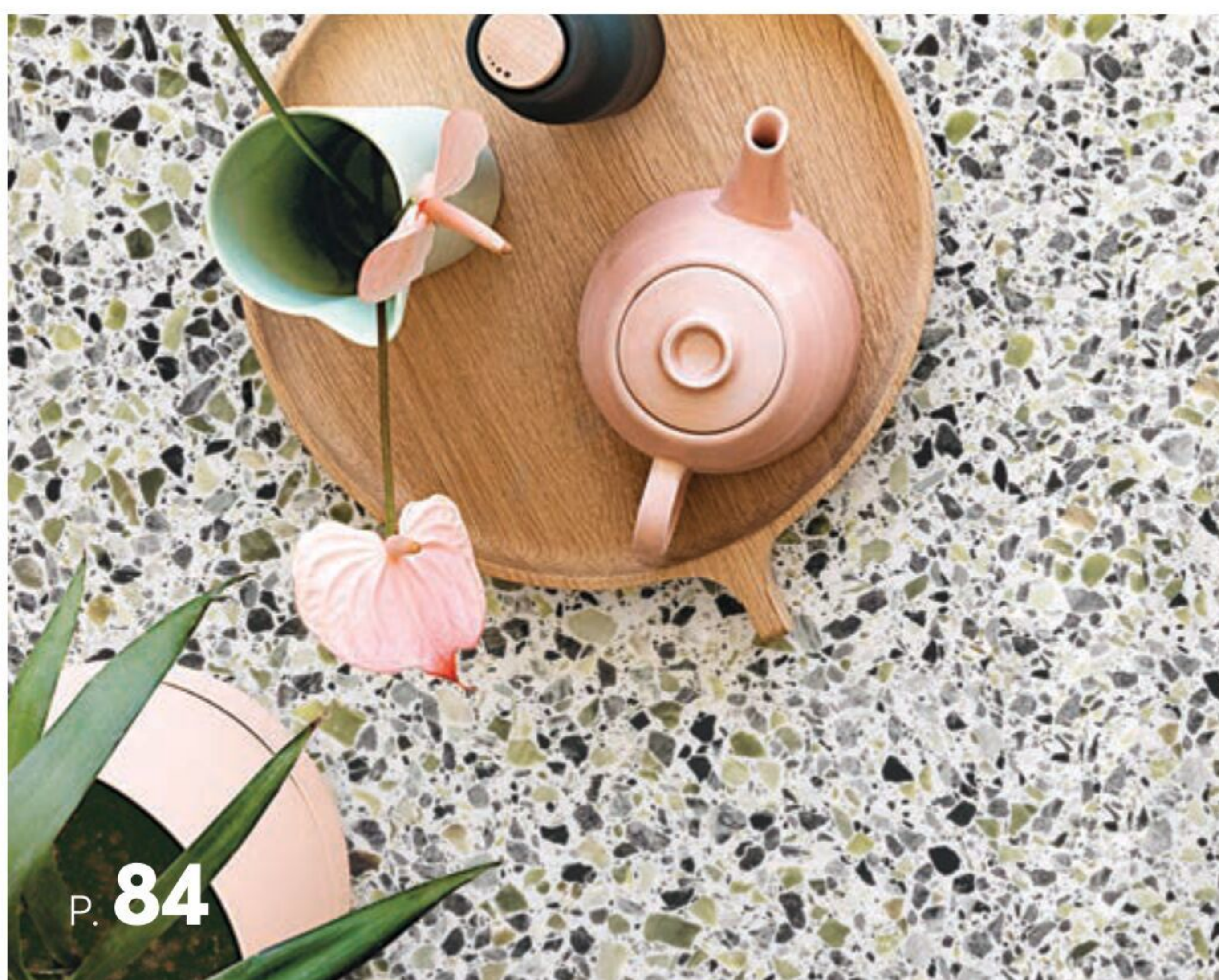

P. 84

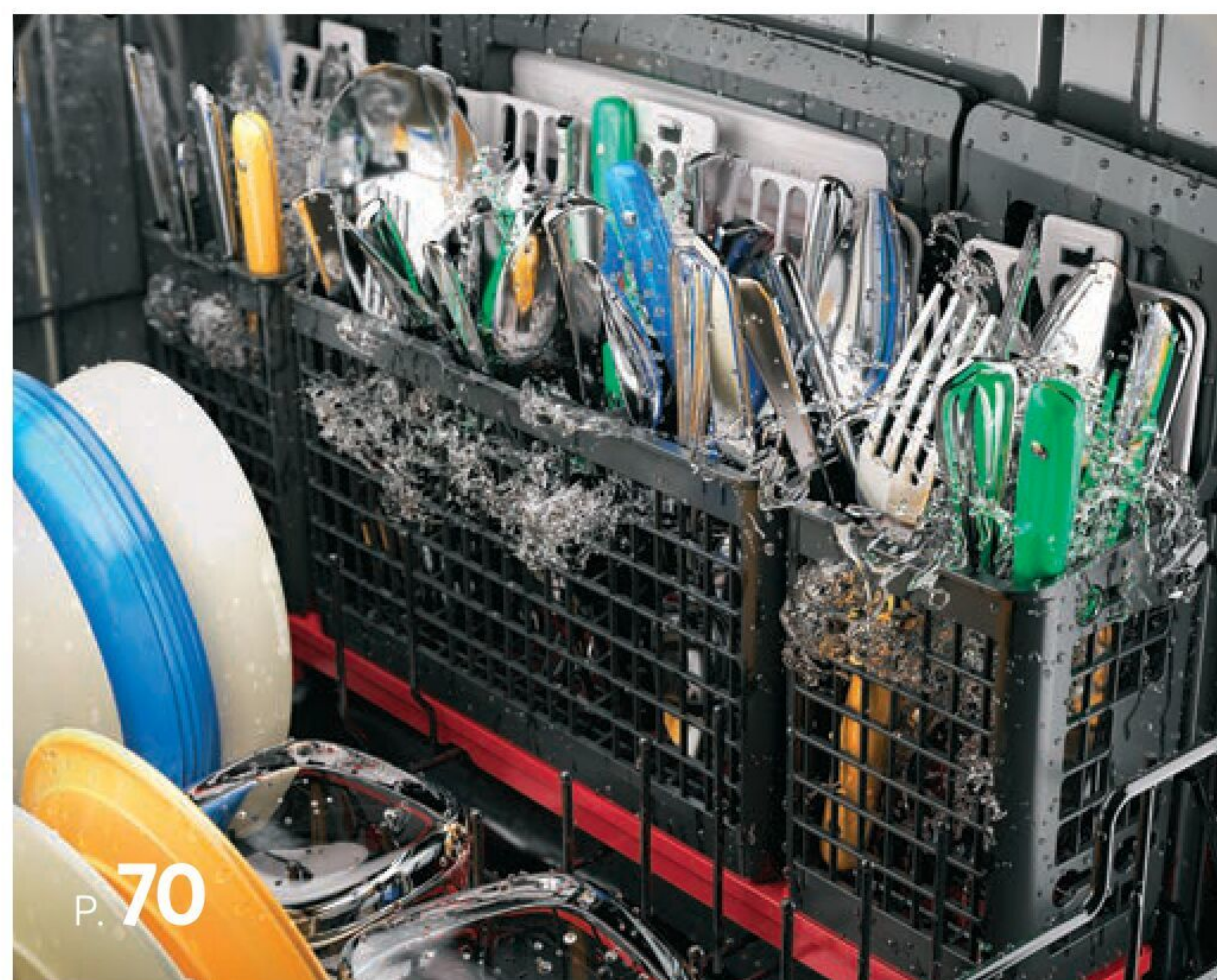

P. 70

3 Inspiring Updates

Yes, you can get a high-style look for less. Just follow the lead of these style-savvy, budget-smart makeovers.

6 Weekend Makeovers

These six DIY projects can make your space look and work better—no major remodel required.

12 How to Save Big on New Appliances

Use these inside tips to get the appliances you need at great prices. Plus: Best and



P. 18

worst places to shop, from our exclusive surveys.

18 Cooking Tools for Every Kitchen

Remodeling? Take the opportunity to upgrade your out-of-date countertop appliances, too. Here's a look at the top-rated models from our latest lab tests, including air fryers, multi-cookers, and toaster ovens.

APPLIANCES

26 Fresh Fridges

Top-freezer or side-by-side? French-door or bottom-freezer? Use our expert buying advice and ratings to find the right style and features for your kitchen.

40 Range Finder

Shop smarter with insights from our test labs. Plus: Why pro-style ranges aren't always as good as they look.

50 Choice Cooktops

Our tests reveal great options for gas, electric, and electric-induction cooktops. Find the best one for your space right here.

58 Exceptional Ovens

Wall ovens are handy when you're cooking for a crowd and offer design flexibility, but they can be pricey. Here's what to know before you splurge.

62 Multitasking Microwaves

Some new microwaves can bake, grill, and brown. Our test results show you which features can add real convenience—and which are just unnecessary extras.

70 Dish Duty, Done

Cleaner dishes and quieter operation using less energy and water—our top models do it all. Find the best performance and value here.

DESIGN ELEMENTS

78 Kitchen Storage Solutions

Use our buying advice to choose cabinets with the storage you need and a style you'll love for years.

84 Surface Report

Our tough tests reveal which countertop materials can stand up to daily use and abuse with ease. Plus, the messes that stain the worst.

90 Top Floors

Hardwood, tile, vinyl, and more: Let our ratings help you choose the best flooring for your home and lifestyle.

96 Resources

ON THE COVER

Photographer: Andrea Rugg



Your Dream Kitchen for Less

Coming up with a wish list for your new kitchen is easy. You probably have a whole idea file of top-performing appliances, gleaming counters and floors, and storage for miles. But figuring out how to make those wishes come true—within the confines of your real-life budget? That part's not always so easy.

The good news: CR is here to help. Our team of home pros—reporters, engineers, and market analysts—has taken a close look at the style, performance, features, reliability, and value of hundreds of products, to help you get the most for your money every step of the way.

When you're ready to shop, just turn to the Buying Guide on page 24. You'll find exclusive ratings and reviews based on our in-house

tests and on our surveys of CR members' experiences with the products in their homes. You can trust our advice because we're nonprofit and independent: We buy all the products we test, and we accept no ads.

So take another look at your wish list—and relax. With CR's smart savings advice, you can make the kitchen of your dreams an affordable, beautiful reality.

—The Editors of
Consumer Reports

RATINGS Overall Scores are based on a scale of 0 to 100. We rate products using these symbols:

🔴 POOR
 🟡 FAIR
 🟢 GOOD
🟢 VERY GOOD
 🟢 EXCELLENT

GREAT Kitchens On a Budget™

President and CEO Marta L. Tellado

Senior Vice President, Chief Operating Officer Leonora Wiener
Vice President, Chief Content Officer Gwendolyn Bounds

Editorial Director, Print Ellen Kunes

Deputy Editor, Print Publications Amanda Lecky

Design Director Matthew Lenning Creative Director, Brand Young Kim

Associate Design Director Sheri Geller

Art Directors Lisa Slater, Tracy Stora

Photo Editors Emilie Harjes, Karen Shinbaum

Senior Director, Content Development Glenn Derene

Deputy Director, Content Development Christopher Kirkpatrick

Associate Directors, Content Development Scott Billings, Althea Chang

Enterprise Kevin Doyle, Editor, Perry Santanachote, Writer/Reporter

Senior Director, Content Impact & Corporate Outreach Jen Shecter

Special Projects Joel Keehn, Director; Margot Gilman, Associate

Director; Lisa L. Gill, Scott Medintz, Rachel Rabkin Peachman, Brian

Vines, Deputies; Ryan Felton, Donna Rosato, Writers

Editorial Director, Digital Erle Norton

Senior Director, Product Testing Maria Rerecich

Associate General Counsel Camille Calman

Director, Lab Operations Lilian Kayizzi

HOME & APPLIANCE: Sara Morrow, Content Lead *Editors/*

Writers: Daisy Chan, Tanya Christian, Mary Farrell, Keith Flamer,

Paul Hope, Haniya Rae, Daniel Wroclawski *Product Testing:* John

Galeotafiore, Emilio Gonzalez, James Nanni, Testing Leads; John

Banta, Susan Booth, Tara Casaregola, Lawrence Ciufu, Enrique de

Paz, Bernard, Deitrick, Cindy Fisher, Rich Handel, Misha Kollontai,

Ginny Lui, Joan Muratore, Joseph Pacella, Christopher Regan, Frank

Spinelli, Dave Trezza *Market Analysts:* Mark Allwood, Claudette

Ennis, Kelly Moomey, Courtney Pennicooke, Antonella Pomilla,

Marion Wilson-Spencer

Chief Scientific Officer James H. Dickerson

Food Safety James E. Rogers, Director; Sana Mujahid; Tunde Akinleye,
Amy Keating

Content Operations Robert Kanell, Director

Copy Editing Leslie Monthan, Copy Chief; Noreen Browne,
Alison France, Wendy Greenfield

Fact Checking & Research David Schipper, Associate Director;
Tracy Anderman, Sarah Goralski, Christine Gordon, Karen Jacob,
Jamison Pfeifer

Premedia William Breglio, Associate Director; Eugene Chin, William
Hunt, Anthony Terzo

Production Nancy Crowfoot, Associate Director; Eric W. Norlander,
Manager; Letitia Hughes, Terri Kazin, Aileen McCluskey

Photography John Powers, John Walsh

Imaging Francisco Collado, Mark Linder

Chief Research Officer Kristen Purcell

Consumer Engagement Testing Charu Ahuja, Director; Samuel
Chapman, Linda Greene, Dana Keester

Statistics & Data Science Michael Saccucci, Director; Debasmita Das,
Kristen Dorrell, Dina Haner, Keith Newsom-Stewart

Survey Research Karen Jaffe, Simon Slater, Associate Directors; Dave
Gopoian, Kendra Johnson, Debra Kalensky, Martin Lachter, Jane
Manweiler, John McCowen, Adam Troy, Tian Wang, Tess Yanisch

Consumer Insight Frank Yang, Associate Director; Selina Tedesco

Marketing Dawn Nelson, Senior Director

Procurement Operations Steven Schiavone, Associate Director

Administration Decarris Bryant, Dawn Yancy Elleby

VICE PRESIDENTS: Financial Planning & Analysis JoAnne Boyd;

Chief Digital Officer Jason Fox; **Advocacy** David Friedman;

Chief Intelligence Officer Esther Han; **General Counsel** Michael

Hubner; **Research, Testing & Insights** Liam McCormack; **Chief**

Human Resources Officer Rafael Pérez; **Chief Marketing Officer**

Lauren Stanich; **Chief Social Impact Officer** Shar Taylor; **SVP, Chief**

Financial Officer Eric Wayne

CR™ Copyright © 2021 Consumer Reports, Yonkers,
New York 10703. Published by Consumer
Reports, Yonkers, New York 10703. All rights
reserved, including the right of reproduction in
whole or in part in any form. ISSN: 2767-1739.
Manufactured in the United States of America.

CONNECT WITH US



FACEBOOK

fb.com/consumerreports
fb.com/SomosCR



TWITTER

@consumerreports
@SomosCR



YOUTUBE

/consumerreports



PINTEREST

/consumerreports



INSTAGRAM

@consumerreports



LINKEDIN

/company/
consumer-reports



Inspiring Updates

THESE MAKEOVERS ARE BRIMMING WITH BRILLIANT, BUDGET-SAVVY IDEAS TO BORROW FOR YOUR OWN KITCHEN REFRESH.

BOLD PERSONALITY

A once-basic space got a high-energy upgrade, thanks to new tile, paint, and creative problem-solving.

Inspiring Updates

BIG STYLE UPGRADE ON A VERY SMALL BUDGET

When Rick and Jessica Rettinger bought their Betavia, Ohio, home, they knew they would update the kitchen, even though it wasn't in terrible shape. "We wanted to add our own style, and help the kitchen flow better with the look of the rest of the house," Jessica says. So the couple, seasoned DIYers who rehab homes for a living (and the busy parents of four), set about giving their basic kitchen a personality infusion—on a strict \$2,500 budget. "We knew it wasn't our forever house, so we didn't want to spend a lot," Jessica

says. "Instead, we put in a lot of time and elbow-grease." First up: the cabinets. New units weren't in the plan, so Jessica and Rick opted to rearrange and re-invent what they had. They removed the upper cabinets on the range wall, installing open shelves in their place. Discovering that the backs of the cabinet doors had a simple, Shaker-style design, they

turned them around before painting in a rich forest green (Benjamin Moore's Yorktowne Green HC-133). A mix of graphic tiles and painted wood paneling on the walls adds rich pattern and texture that's balanced by the warm natural-wood shelves and counters. The new look is fresh and fun—and just right for the young family.

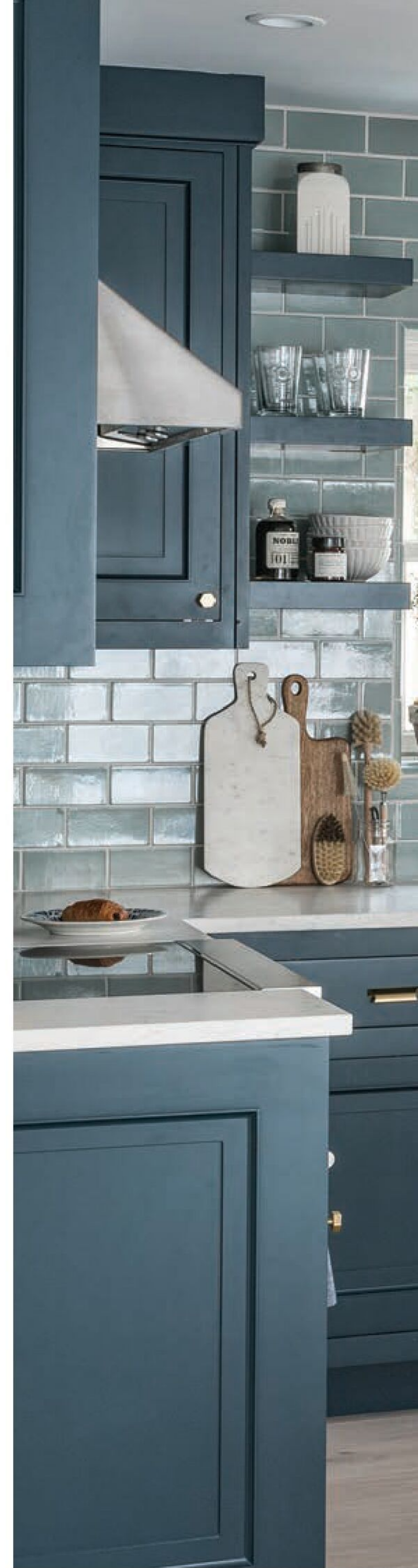

**BRIGHTER
& BETTER—
BUT NOT ANY
BIGGER**

Dark and dreary aren't the adjectives you want to describe your beach-house kitchen. So when planning

PHOTO, PREVIOUS PAGE: JESSICA RETTINGER



PHOTOS, THIS SPREAD, FROM LEFT: JESSICA RETTINGER; WILL TAYLOR (AFTERS)

his seaside rehab, interior design author Will Taylor's first priority was "more light and color." And though his budget didn't have room for an addition, he also wanted to maximize counter and storage space in the compact kitchen. The key to achieving all those goals? Removing the half wall that partially

enclosed the kitchen. Now there's an easy flow between spaces and plenty of room for another must-have: a large dividing island with a durable quartz countertop and hidden storage within. Inside the kitchen, new cabinets and shelves offer more storage and display space. The range and

fridge swapped places to create a better workflow, but the sink kept its original spot to avoid relocating the water line (a smart money move). A beachy palette adds the color Will loves, but the best improvement is how open the space now feels, he says. "The footprint is the same, but it looks twice as big!"

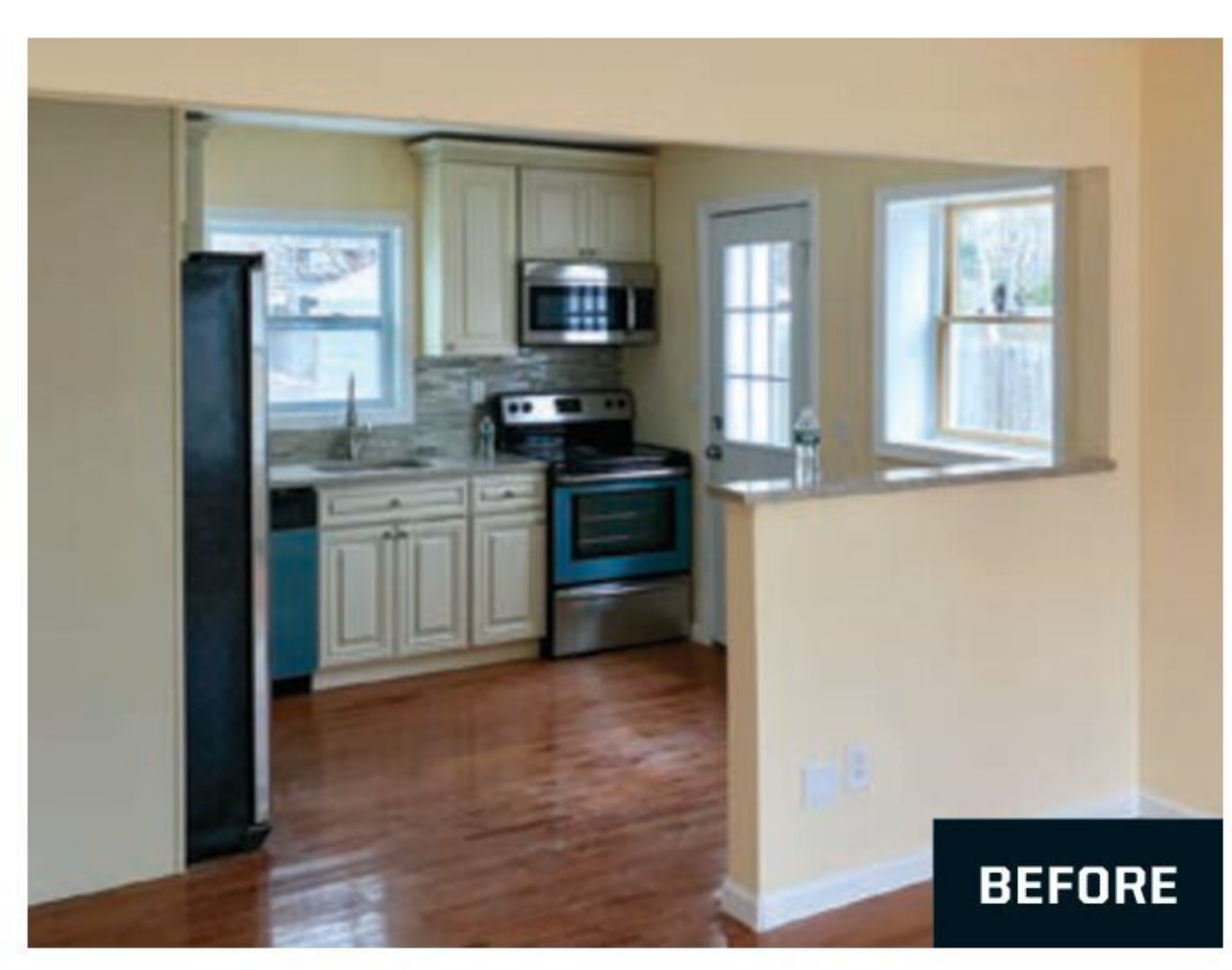

BEFORE

Weekend Makeovers

NOT READY TO COMMIT TO A MAJOR REMODEL? TRY THESE SIX SIMPLE DIY UPDATES TO REBOOT YOUR KITCHEN'S STYLE, FAST.





1. Get Personal With Paint and Paper

A fresh coat of paint—try our top-rated interior paint, Behr Marquee, \$45 per gallon—can give new life to old cabinets. Pro tip: Don't rush the prep work (removing doors, cleaning, and sanding). It's the key to a smooth finish. Want a dash of pattern? Peel-and-stick wallpaper adds low-commitment flair.



Weekend Makeovers

2. Create a Fun Focal Point With Tile

Tiling a high-impact wall area is a DIY-friendly job, even if you've never tiled before. Simplify the task by choosing a style that comes as a square of multiple tiles affixed to a mesh backing so that the spacing is done for you. And avoid designs that continue from one tile to the next, requiring precision placement and cutting to maintain the pattern. Budget bet: Check big box stores for less-expensive look-alikes for popular and pricey handmade styles.



3. Improve Work Flow With a Rolling Island

Problem: You could really use more counter space (who couldn't?), but adding a built-in peninsula or island isn't in the budget. **Solution:** a rolling kitchen cart or island. A quick online search will turn up a wide variety of options with different styles, sizes, and prices—any of which will increase your counter area and add open or closed storage, as well. When you need more floor space in your kitchen, just roll the cart out of the way.



4. Update Cabinets With Fresh Handles and Knobs

It may not seem like much of a change, but replacing your cabinet hardware can make a surprisingly big impact on the look of your space. For example, trading 1990s polished chrome for 2020s matte black—or luxe and timeless brushed brass—can be just the subtle refresh your kitchen needs. **Hint:** Take the old handles with you to the store so that you won't have to drill new screw holes because you bought the wrong size.



Weekend Makeovers

5. Make It Modern With Statement Lighting

The right pendant lights can add more than key task illumination above prep, cooking, or cleanup areas; they can also add some serious style to your space. For a bold impact, look for oversized designs and rich finishes. But avoid fabric or woven shades in grease-prone areas.





6. Install Open Shelves for Storage and Interest

They're a popular feature in many modern kitchens, and for good reason: Open shelves are typically less expensive than wall cabinets, and they create easy access to essentials or an eye-catching display spot. During installation, always screw supports into wall studs—or risk tumbling treasures.



HOW TO SAVE BIG ON NEW APPLIANCES

SHORTAGES CAUSED BY THE PANDEMIC HAVE MADE BARGAIN-HUNTING A LITTLE MORE DIFFICULT. BUT OUR INSIDE TIPS CAN STILL HELP YOU GET THE TOP MODELS AT THE LOWEST PRICES. PLUS: THE BEST (AND WORST) PLACES TO SHOP.



I

If you're shopping for a new refrigerator, range, or dishwasher—or all three—for your kitchen update, you'll probably

find the retail landscape somewhat changed. The appliance shortage brought on by the coronavirus pandemic is still rippling through retailers in the U.S., meaning that many models are harder to get, especially if you need them fast. Deals are even more scarce. To get a bargain, you need to be alert and flexible—and willing to pounce.

Lower Discounts and Fewer of Them

As Americans began spending more time at home last spring, they took a closer look around their kitchens and started ordering replacements and

upgrades for their appliances. With that increased demand, manufacturers didn't need to give retailers the usual rebates to help them move merchandise. And that means the Best Buys and Lowe's of the world haven't been passing along the cost cuts to you in the form of deep discounts.

In January of 2021, for example, Best Buy advertised just 14 discounted refrigerators—it listed 100 at the same time in 2020—and Lowe's didn't advertise any discounted refrigerators at all, according to Gap Intelligence, a market research company. And even when a store does offer a discount, the actual savings aren't as great, says Seth Basham, managing director at Wedbush Securities, based in Los Angeles, and an industry analyst who covers appliance retailers. "Discounts may appear similar," he says, "but base pricing or other factors will likely make the

products more expensive compared with last year."

Then there's the problem of supply shortages as manufacturers struggle to recover from factory closings and make production changes for COVID-19 safety protocols to protect workers. "The Asian economies were hit in particular by the lockdown, so there was a period of six to eight weeks when nobody in Asia was making steel," says Tom Derry, CEO of the Institute for Supply Management, an industry group in Tempe, Ariz. "All of that adds up to months of backlog."

Some Appliances Are Hard to Get

No matter how much you're willing to spend, you may not be able to get your hands on the appliance of your dreams.

More than one-third of refrigerator models were out of stock at major

Where to Shop and Save

appliance retailers in January of 2021, compared with about one-fifth at the same time in 2020, according to Gap Intelligence. “Before COVID-19, when you typed in the model number at some retailers’ sites, they’d say ‘available now,’ or ‘three left, order soon,’” says CR’s head shopper, who buys appliances for our tests. “Now, they sometimes won’t give a date at all.”

“Back orders are still very high,” says Ken Miele, CEO of the Appliance Dealers Cooperative, which is based in New Jersey and buys appliances from manufacturers to distribute to about 200 independent retailers, mainly in the East.

Many followers of CR’s “Consumer 101” Facebook page have reported waiting months for appliances as deliveries are pushed back multiple times. Cindy and Randy Wilmore of Columbia, Tenn., are just one example. They ordered a dishwasher in mid-June of 2020 with a delivery promise six months later. “Never in a million years did we

think it would take this long to replace appliances,” Cindy says.

Good News: You Can Still Find What You Need at a Great Price

Appliance shopping may be a bit more challenging these days, but that doesn’t mean you’re out of luck. Here’s our insider’s advice for getting what you need pronto for less.

1 TRY AN INDEPENDENT RETAILER. Local independent retailers can offer selections comparable to those of big-box stores, thanks to their membership in cooperative buying groups. “They may have more inventory stocked—or be more inclined to sell the floor model,” says Mark Davis, an analyst for Gap Intelligence.

Independents may also offer superior service and other perks that can make the buying experience more pleasant. Marla Collins of Midlothian, Va., a fan of the “Consumer 101” Facebook group, says her local appliance dealer lent

her a refrigerator while she waited for her new Whirlpool last summer. “The loaner helped tremendously,” she says.

If you see lower prices at big-box stores, it’s worth asking whether an independent will match them. For CR’s exclusive ratings of independent and big-box appliance retailers, see page 17.

2 USE ONLINE TOOLS TO DO RESEARCH. Take advantage of a retailer’s online shopping filters to narrow your appliance search to what’s in stock or in stores now. If you want to see an appliance in person, some retailers, like Lowe’s, will tell you the nearest store that has the model you’re considering. Use the online chat if it’s available, too. We tried Home Depot’s, and a rep spent half an hour helping us find an in-stock LG French-door fridge. When you head to a store, follow the safety tips in “Pandemic Shopping Precautions” on the facing page.

3 DON’T RULE OUT BUYING ONLINE. Quite a few members of our “Consumer 101” Facebook group told us this summer that they had purchased large appliances online, either to protect their health or because their preferred stores were closed at the time they needed the appliance.

The increase in online purchases of large appliances predates the pandemic, though. Among our members surveyed about their purchases between January 2019 and April 2020, more than 1 in 5—22 percent—had bought a large appliance on-line. That’s double the percentage from our 2014 survey.

In some instances, you can only view and purchase large appliances online. Costco Wholesale, for instance, keeps only a fraction of its appliance offerings on view at its warehouses; you can find the bulk of its inventory online. With the exception of a few floor-model sales, it requires nearly all purchases to be made online.

Many retailers have beefed up their websites and apps to make it easier for consumers to shop remotely. Nebraska Furniture Mart in Omaha, for instance,



can demonstrate appliance features via video. Home Depot's app provides a two-dimensional image of an appliance on your smartphone. You can then use your phone's camera to place that image in your home virtually, so you can see how it looks.

Ordering online often comes with free shipping, although you probably can't skip out on tax. And you can still attempt to haggle by contacting a customer-service rep either by phone or in an online chat.

4 PRIORITIZE YOUR MUST-HAVES. When inventory is limited, it helps to be flexible with features. For instance, Nish Suvarnakar, a market analyst at CR for major appliances, recommends choosing basic stainless steel instead of a specialty finish like black or "Tuscan" stainless, because it's a popular finish that's often manufactured in larger batches.

5 REMEMBER, NOT EVERY SUITE IS A SWEET DEAL. You might be tempted by offers and rebates on matching kitchen suites—typically a refrigerator, range, dishwasher, and microwave from the same maker. But Consumer Reports' member surveys suggest that it's difficult to find brands that are tops for reliability across all four categories. For instance, LG has top reliability scores for top- and bottom-freezer refrigerators. But reliability for its dishwashers is middling.

Appliances by the same brand within the same general category can also receive different reliability ratings. For instance, LG's French-door and side-by-side refrigerators are rated just Good.

6 ALWAYS TRY FOR A BETTER BARGAIN. Whatever the listed price—even one that has been discounted—you may be able to get an even better bargain by haggling.

In a member survey conducted by CR, 28 percent of major-appliance shoppers haggled for a better price, and those who succeeded—72 percent of those who tried—ended up saving a median of \$113.

Pandemic Shopping Precautions

If you plan to shop in person, take the following protective measures.

■ **GO WHEN TRAFFIC IS LOW**

Do a Google search for the retailer to see if you get a chart showing the times when the store is less busy. If you're an older person or in a vulnerable population, call to ask about special hours reserved for you. Keep a distance from staff and other shoppers.

■ **MAKE AN APPOINTMENT**

Set a specific time to meet with a salesperson if possible, so that you don't have to wait around. Prepare questions ahead of time. If you can't make

an appointment, tell the salesperson that you want to expedite the shopping process.

■ **PLAN FOR CONTACTLESS PAYMENT**

You can download a mobile app such as Apple Pay or Google Pay to check out by waving your smartphone above the card reader. Or pay with a credit card with radio-frequency identification (RFID) technology, which lets you do the same thing without having to swipe the card or sign.

■ **WEAR A MASK**

As with any public outing, remember to wear a mask. Bring hand sanitizer that's at least 60 percent alcohol to use after touching appliances.

Wash your hands with soap when you get home.

■ **PREPARE FOR THE DELIVERY**

When the company contacts you to arrange delivery, ask that the people delivering your appliance follow safety protocols, including wearing masks, using hand sanitizer, and staying at least 6 feet away from you. Keep windows open to circulate air, which helps reduce airborne virus particles. If possible, stay out of the room during installation. Clean the appliance with soap and water afterward—and surrounding countertops—and wash your hands.

Among the most successful negotiating tactics when shopping for a major appliance were checking competing retailers' websites to compare offers, and purchasing multiple items at once. (Of course, you'll probably want to return or cancel the items purchased at the higher price.)

Other effective steps our members used include asking for a senior, veterans, or membership discount; referring to prices found at other walk-in retailers; and checking deals at price-comparison websites.

If none of the above strategies pan out with a lower price, try this winning trick: Ask whether you can buy an

open-box or floor model, or one that's slightly blemished (in a spot that won't show) for less.

7 GET THOSE FREE EXTRAS.

Even if you fail to chip away at the sale price, there are other ways to save when buying a large appliance, such as asking the retailer to waive fees for shipping or delivery. Many of them already offer this service and also include free hauling away of your old appliance.

And always ask whether installation is included, especially if you're just replacing one appliance with another rather than undertaking an entire kitchen remodel.

Best & Worst Appliance Stores

If you need to replace an appliance, you can't go wrong by shopping at Abt or Costco Wholesale. Both retailers get high marks from nearly 48,000 CR members who told us about their experiences buying more than 76,000 major and small appliances at 39 chain retailers across the U.S., as well as from independent retailers and manufacturers' websites.

BIGGER MAY NOT BE BETTER

Among our survey findings: The biggest stores aren't always the best. Abt, for example, has only one big walk-in warehouse, in suburban Chicago, but it ships across the country. It heads our ratings of major-appliance retailers for the 11th survey in a row. And independent retailers and websites, which can range from a single-store mom-and-pop shop to a regional chain, rank among the top major-appliance retailers.

None of the big-box stores with hundreds of locations—Best Buy, Home Depot, Lowe's, and Sears—rate in the highest tier for either small or large appliances. But web behemoth Amazon is among the top-rated retailers for small appliances.

STORE PERFORMANCE CAN BE UNEVEN

Certain retailers earned only Poor or Fair scores for individual attributes. While all three of the warehouse clubs—BJ's Wholesale Club, Costco and Sam's Club—earn the lowest possible rating for small-appliance selection, BJ's and Sam's also crater in their scores for service. For small appliances, Walmart gets the lowest possible rating for service and in-store atmosphere. Canadian Tire scores the same for service.

But even Walmart receives a

score of Very Good for overall shopping experience. In fact, all but one of the small- and large-appliance retailers in our ratings received high or very high scores for overall satisfaction. The exception is Appliance Factory Outlet; members report so-so overall satisfaction with the retailer, which has stores in Colorado, Indiana, and Ohio but ships nationwide.

Indeed, something about the shopping experience at these retailers gives our members a more positive feeling overall than what each of our six ratings categories may capture on their own. So while a retailer may not fare well on certain attributes, members may still report a satisfactory shopping experience overall.

SHOPPING GRIPES

We asked members to name a retailer where they shopped but didn't purchase what they were looking for. They told us about the gripes they had with that retailer. The most commonly reported complaint? High prices.

Many shoppers also complained about out-of-stock products and a lack of brand or model choices. (Our survey covered purchases made from the beginning of 2019 to the middle of 2020, and may not fully reflect the retailer inventory problems that stem from the pandemic.) Fewer shoppers cited limited display models, lack of sales help, and salespeople who didn't seem knowledgeable.

WARRANTIES AND SERVICE CONTRACTS

We found that it's rarely worthwhile to purchase an extended warranty. Yet two-thirds (68 percent) of major-appliance buyers said retail staffers suggested, without pressure, that they buy one. Among small-appliance buyers, about one-third—31 percent—had the same experience.

And some people got the hard sell. Among buyers of major appliances that didn't come with a free extended warranty or service contract,

8 percent said they were strongly urged to buy an extended warranty or service contract. Some retailers were pushier than others. Twenty-one percent of those who bought their major appliances at Sears were strongly urged to buy a warranty. Eighteen percent of buyers at P.C. Richard & Son and 17 percent at Bray & Scarff felt pressured as well.

Pressured or not, 18 percent of major-appliance shoppers end up buying extended warranty or a service contract. Two percent of small-appliance buyers do the same.

If an extended warranty is something you want to pursue, first check the benefits of the credit card you plan to use.

Your card may automatically extend your purchase's warranty so you don't need to buy extra protection. If you still want to take advantage of a retailer's warranty, keep in mind that the period of coverage can differ. The cost of the warranty may vary accordingly.



PHOTO: STARUSH/ADOBE STOCK



Retailer	Reader Survey Results						
	Overall satisfaction score	Price paid	Selection	Service	In-store atmosphere	Website usability	Home delivery

MAJOR APPLIANCES

Abt	94	↑	↑	↑	↑	↑	↑
Famous Tate	93	↑	↑	↑	↑	—	↑
Albert Lee Appliance	92	↓	↑	↑	↑	—	↑
Costco	92	↑	↓	↓	↑	↑	↑
Nebraska Furniture Mart	92	↑	↑	↑	↑	↑	↑
Warners' Stellian	91	↓	↑	↑	↑	↑	↑
Independents	91	↓	↑	↑	↑	↓	↑
Orville's Home Appliances	90	↑	↑	↑	↑	—	↑
Spencer's TV & Appliance	90	↓	↑	↑	↑	↓	↑
Amazon.com	89	↓	↑	—	—	↑	↑
Pacific Sales	89	↓	↑	↑	↑	—	↑
R.C. Willey Home Furnishings	88	↓	↑	↑	↑	↓	↑
ABC Warehouse	88	↓	↑	↑	↓	—	—
Sears Hometown Stores	87	↓	↓	↑	↓	↓	↑
Ferguson	87	↓	↑	↑	↑	↓	↑
Best Buy	87	↓	↑	↑	↑	↑	↑
P.C. Richard & Son	87	↓	↑	↑	↑	↓	↑
Grand Appliance & TV	86	↓	↑	↑	↑	↓	↓
Airport Home Appliance	86	↓	↑	↑	↓	—	↓
Lowe's	85	↓	↑	↓	↓	↓	↓
Home Depot	85	↓	↓	↓	↓	↓	↓
Bray & Scarff	85	↓	↑	↑	↑	—	↑
Menards	84	↓	↓	↓	↓	↓	—
Sears	84	↓	↓	↓	↓	↓	↓
Appliance Factory Outlet	77	↓	↓	↓	—	—	—

HOW WE SURVEY: Ratings are based on Consumer Reports' 2020 Spring Survey of 47,947 CR members reporting on 76,288 appliance purchases made between January of 2019 and June of 2020. **Overall satisfaction**

score represents shoppers' overall satisfaction with their retail experience. If all respondents are completely satisfied with a particular retailer, this score would be 100; a score of 80 indicates that respondents are "very

Retailer	Reader Survey Results						
	Overall satisfaction score	Price paid	Selection	Service	In-store atmosphere	Website usability	Home delivery

SMALL APPLIANCES

Abt	94	↑	↑	↑	—	↑	—
Exchange	94	↑	↓	—	—	—	—
Sur La Table	93	↓	↑	↑	—	—	—
Williams Sonoma	93	↓	↑	↑	↑	↑	—
Costco	92	↑	↓	↓	↑	↑	—
QVC.com	91	↑	↓	↑	—	↑	—
Amazon.com	90	↓	↑	↓	—	↑	—
Bed Bath & Beyond	90	↓	↑	↓	↓	↓	—
Kohl's	90	↑	↓	↓	↓	↓	—
Macy's	89	↑	↓	↓	↓	↓	—
Manufacturers' websites	89	↓	↑	↓	—	↓	—
Sam's Club	89	↑	↓	↓	↓	↓	—
Independents	89	↓	↓	↑	↑	↓	—
Best Buy	89	↓	↓	↓	↓	↑	—
Target	88	↓	↓	↓	↓	↓	—
Meijer	88	↓	↓	—	↓	—	—
JCPenney	88	↑	↓	—	↓	—	—
BJ's	88	↑	↓	↓	↓	↓	—
HSN	87	↓	↓	—	—	↑	—
Canadian Tire	86	↓	↓	↓	↓	↓	—
Home Depot	86	↓	↓	↓	↓	↓	—
Walmart	85	↓	↓	↓	↓	↓	—
P.C. Richard & Son	85	↓	↓	↓	↓	—	—
Lowe's	84	↓	↓	↓	↓	↓	—
Sears	84	↓	↓	↓	↓	↓	—
Menards	84	↓	↓	↓	↓	—	—

satisfied," on average. Differences of less than 4 points are not meaningful. The other attributes listed under **reader survey results** reflect average scores on a scale from "very poor" to "excellent." Ratings are based on the

experiences of CR members, who may not be representative of the general US population. Dashes (—) indicate insufficient sample size to provide a rating or that an attribute is not applicable to a retailer.

WHAT IS AVAXHOME?

AVAXHOME-

the biggest Internet portal,
providing you various content:
brand new books, trending movies,
fresh magazines, hot games,
recent software, latest music releases.

Unlimited satisfaction one low price

Cheap constant access to piping hot media

Protect your downloadings from Big brother

Safer, than torrent-trackers

18 years of seamless operation and our users' satisfaction

All languages

Brand new content

One site



AVXLIVE **ICU**

AvaxHome - Your End Place

We have everything for all of your needs. Just open <https://avxlive.icu>

COOKING TOOLS FOR EVE



TOAST

AIR FRYER
GOWISE
USA GW22731
\$80

73

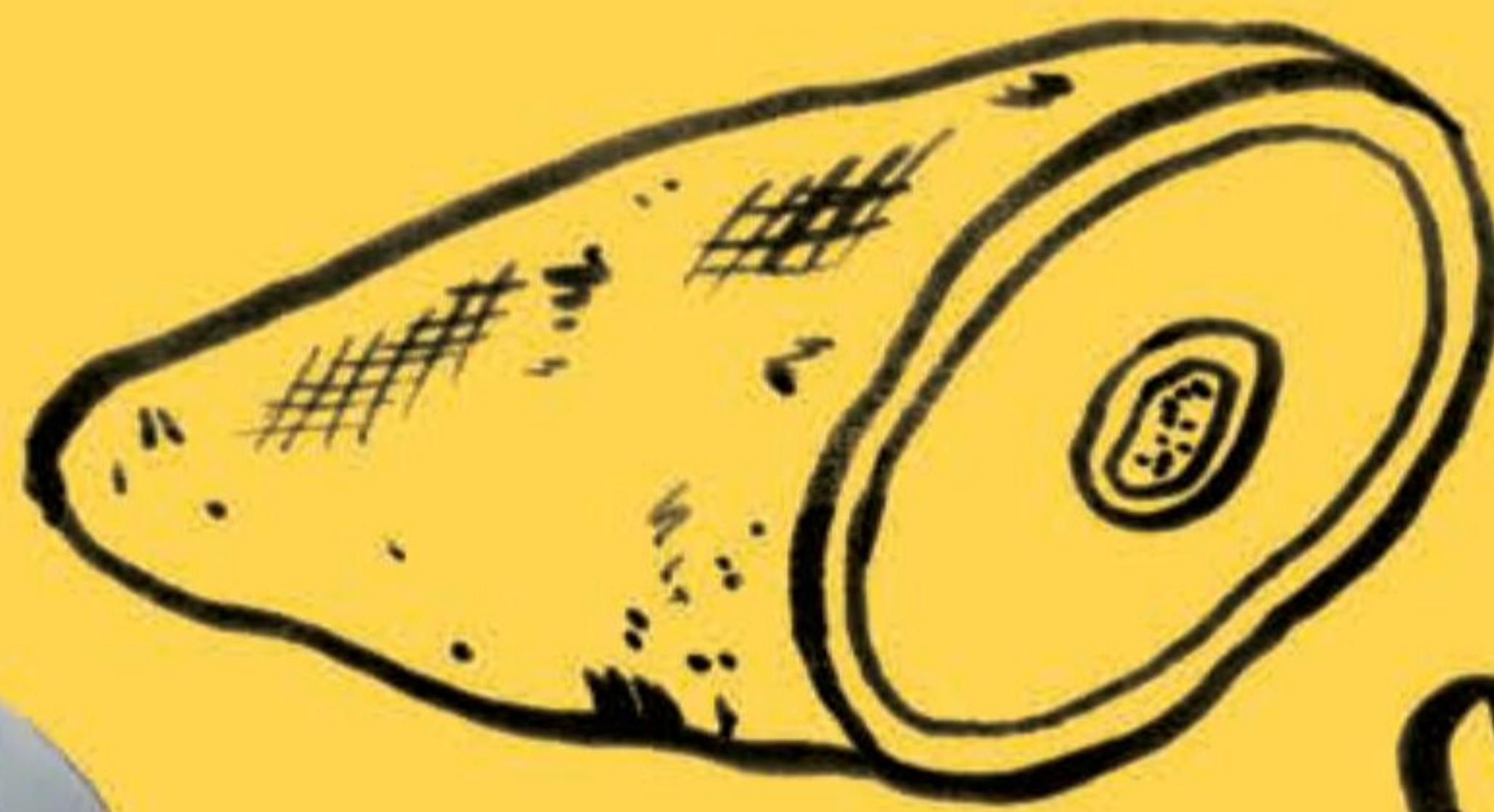

RY KITCHEN

THE RIGHT COUNTERTOP APPLIANCES CAN MAKE YOUR MEAL PREP FASTER AND EASIER—AND LOOK GREAT DOING IT. HERE'S WHAT YOU NEED TO KNOW TO PICK THE TOP-PERFORMING AIR FRYERS, MULTI-COOKERS, TOASTER OVENS, AND MORE.

BROWN

TOASTER OVEN
✓ BLACK+DECKER
8-SLICE DIGITAL
EXTRA WIDE
TO3290XSD
\$100

68



MULTI-COOKER
✓ ZAVOR LUX
LCD ZSELL02
\$160

82



PREPARING THREE MEALS a day at home can get tedious—even if you love to cook. These multitaskers can simplify job, leaving you more time for the kitchen tasks you actually like or for enjoying yourself outside the kitchen. Plus, they are perfect for preparing side dishes, freeing up your oven so that your main course can cook on its own. “Small-appliance technology has become so advanced over the past decade that some of them can do most everything an oven can do, just on a smaller scale,” says Emilio Gonzalez, associate director of lab operations at Consumer Reports.

For instance, in the past only an oven could convection-roast a whole chicken and cook stews low and slow. But those functions, along with others, can now be found in toaster ovens, air fryers, and multi-cookers. And there is another reason to appreciate their multitasking abilities: You can save storage space. Here, we offer suggestions for the best ways to use these appliances. And check out the ratings at the end of this article to find the right models for you.

SLOW COOKER

A slow cooker is the ultimate hands-off helper. Just place the ingredients in the appliance in the morning, set it to high or low, and come back later to a hot, ready-to-serve meal.

Common mistakes to avoid:

Because cooking temperatures are low, the Department of Agriculture warns against using frozen meats. They might not reach a safe bacteria-killing temperature.

What's new: Inserts that can go on the stovetop so that you can brown foods before slow-cooking without dirtying a separate pan.

Best for: Soups, stews, beans, and tough cuts of meat, such as brisket, that you want to turn out fork-tender. And slow cookers do a great job with custard-based desserts such as flan and recipes that call for a water bath—cheesecake, for example.



✓ HAMILTON BEACH
TEMP TRACKER
33866 6 QT.
\$60

87



✓ BLACK+DECKER
DIGITAL WITH
TEMPERATURE PROBE +
PRECISION SOUS-VIDE
SCD7007SSD
\$60

86



✓ CROCK-POT
COOK & CARRY S
CCPVS600ECP-S
\$100

84

BLENDER

Sure, blenders are great for smoothies, but you can also use them to make a velvety purée, a sauce, and more.

Common mistakes to avoid: Hot ingredients can cause certain blenders to malfunction. If the lid doesn't have a vent, heat will build up pressure, which can cause the lid to pop off. So check the manual to see whether hot ingredients can be used.

What's new: A growing number of models can heat ingredients while blending, so you can prepare soup without using the stovetop.

Best for: Blenders make quick work of preparing sauces and soups. And whip up healthy smoothies or other frozen drinks (margaritas, anyone?). Blenders are also great for DIY plant-based milks. For small batches of food, such as fresh salsas and salad dressings, a blender works better than a food processor.

The Value of a Good Rice Cooker

Stovetop rice seems easy enough: You measure out the rice and water, then set the pot on the burner. But there are variables that can lead to mushy or burned rice, including timing, how hot the burner is, the type of pot you use, the tightness of the lid's seal, and even your kitchen's humidity level.

Rice cookers eliminate those variables because they're a sealed vessel with a precisely controlled heat source. The best ones make perfect rice every time

with the press of a button. But our experts wanted to know: Do all rice cookers consistently deliver great rice—and why buy one over a multi-cooker with a rice function?

So we tested six rice cookers from popular brands, cooking small and large batches of long-grain white rice and brown rice. A panel of trained tasters judged each batch in a blind side-by-side taste test. The ideal batch of rice was cooked evenly top to bot-

tom—no mushy or crunchy pockets—with soft, fluffy grains. Then we compared the way the rice tasted from each model with rice made in a multi-cooker. We also evaluated convenience, such as how easy each model was to clean, and the clarity of control settings.

"Most rice cookers perform very well, though some weren't as good at making brown rice," says Larry Ciuffo, CR's lead tester of rice cookers. "But even the lowest-rated rice cookers make

TOASTER OVEN



CR BEST BUY NINJA SMART SCREEN DUO WITH FRESHVAC CT661V
\$170

79



RECOMMENDED INSTANT ACE MULTI USE
\$60

77

A toaster oven is up to almost any task your full-sized oven can accomplish—on a smaller scale. That makes it a smart standby when the oven is occupied or when you're cooking for just one or two.

Common mistakes to avoid: A dark-colored pan accelerates the transfer of heat, which may cause roasted vegetables or cookies to burn. So use a light-colored pan instead, or lower the temperature by 25° F.

What's new: In the past five years certain manufacturers have added features such as air frying, convection, dehydrating, and slow-cooking.

Best for: Baking and broiling are a given. Toaster ovens make great toast, too, but more slowly than a standard toaster. (Based on our tests, toaster ovens take 3 to 9 minutes on the medium setting; toasters take 2 to 4 minutes.)



RECOMMENDED BREVILLE BOV650XL
\$180

76



RECOMMENDED BLACK+DECKER 8-SLICE DIGITAL EXTRA WIDE TO3290XSD
\$100

66



RECOMMENDED HAMILTON BEACH 6-SLICE 31411 TOASTER OVEN
\$65

66

better rice than any multi-cooker we've tested, and often cost much less," he says. And many can also cook other grains.

Of course, a dedicated rice cooker can't slow-cook or pressure-cook meat, so buying one depends on whether grain dishes are a priority for you. The Zavor Lux LCD ZSELL02, \$160 (on page 22), had the best rice-making scores of the multi-cookers tested, but the rice fell short of what was made in the rice makers. At right are the top rice cookers we tested.



PERFECT RICE, BUT PRICEY

RECOMMENDED ZOJIRUSHI NP-GBC05
\$270

76

4/5 RICE COOKING
5/5 CONVENIENCE



BEST FOR SEASONED RICE

AROMA ARC-954SBD
\$40

70

4/5 RICE COOKING
4/5 CONVENIENCE



BUDGET-FRIENDLY BUY

CR BEST BUY INSTANT ZEST 8-CUP
\$30

64

4/5 RICE COOKING
4/5 CONVENIENCE

Are Instant Pot Add-Ons Worth Buying?

One of the selling points of the popular Instant Pot multi-cooker is that it can be used as a slow cooker, pressure cooker, rice cooker, and steamer. But it also offers tempting add-on accessories. Perry Santanachote, a CR staffer, bought nine accessories to see which ones will boost your Instant Pot game and which ones aren't worth your cabinet space.



Air-Fryer Lid*
\$79



This lid comes with a 3.5-quart air-fryer basket that you slip into its inner pot, great for crisping a small batch of fries. It also turns your pot into a mini convection oven capable of roasting, broiling, and more. "It crisped the skin of a whole chicken beautifully," Santanachote said.



Mesh Baskets
\$30

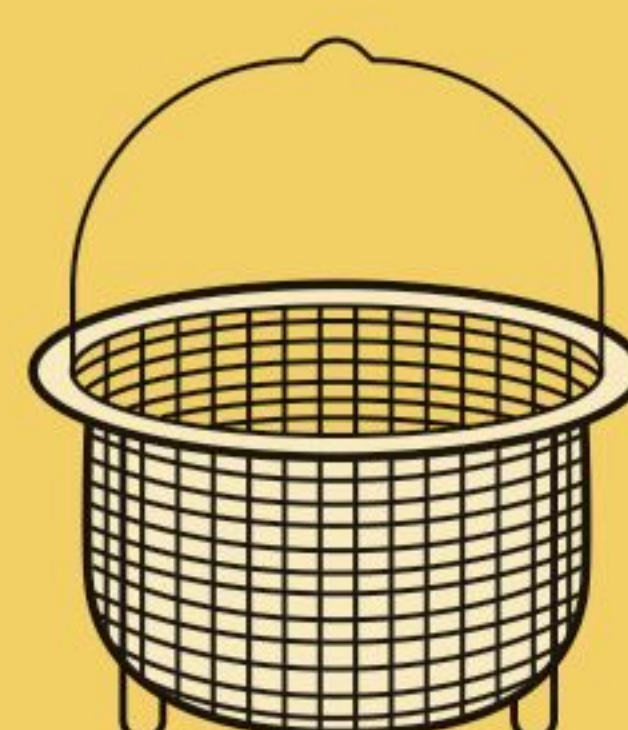

A smaller basket nests inside a larger one, letting you steam two separate vegetables at once. But in our labs, Instant Pot models receive a Fair rating for steaming veggies. Do fine mesh wire baskets help at all? "They didn't for me," Santanachote said after trying them in her home kitchen.



Metal Egg Rack
\$20



Instant Pot egg racks come in metal and silicone. Both hold whole eggs (14 in the metal, nine in the silicone) so that they cook evenly and the yolks stay centered, Santanachote said. The multitiered metal racks are great for "pot in pot" cooking, meaning two dishes at once.



Ceramic Nonstick Inner Pot
\$20



Instant Pot models come with a stainless steel inner pot that's great for most meals "but can be a pain to clean if you make sticky, starchy foods," Santanachote said. The ceramic pot was a breeze to clean, even after cooking cheesy pasta. And it's oven-safe up to 680° F.



Tempered Glass Lid
\$15



The glass lid lets you see what's cooking and provides a looser seal than the pressure-cooker lid. Instant Pot models underperform at slow-cooking in our lab tests, "and this lid didn't make it better for me," Santanachote said. "My beef stew came out tough and watery."



Springform Cake Pan
\$13

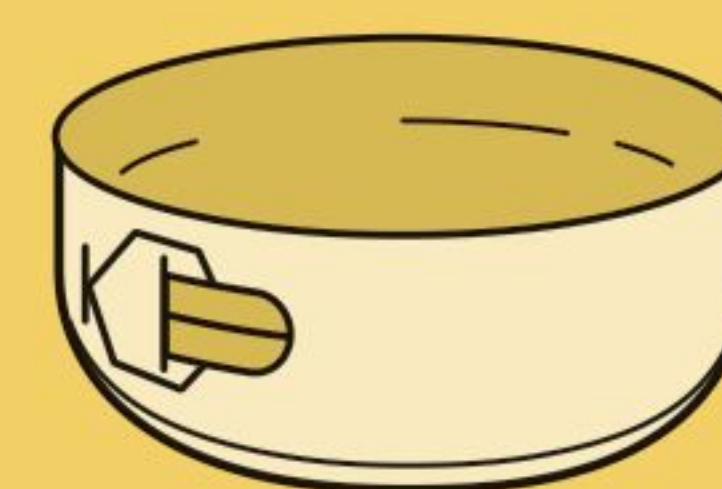

The moist environment of a multi-cooker is ideal for making custardy desserts. It's possible to make cheesecake in your Instant Pot without it. But this 7.5-inch pan is sized to fit snugly in the inner pot and locks into the silicone steam rack (below, left) for easy removal.



Silicone Steamer Basket
\$10

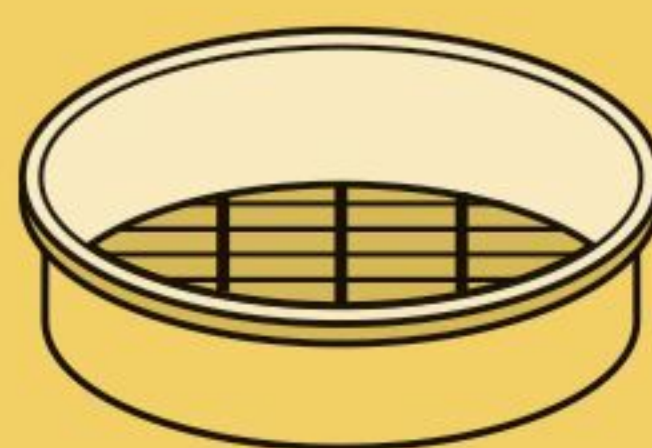

This looks like a traditional bamboo steamer, but the silicone prevents food from sticking. It locks onto the silicone steam rack accessory (at right), and you can nest three of them on top of each other. "It did a great job steaming dumplings and fish in my kitchen," Santanachote said.



Silicone Steam Rack
\$9

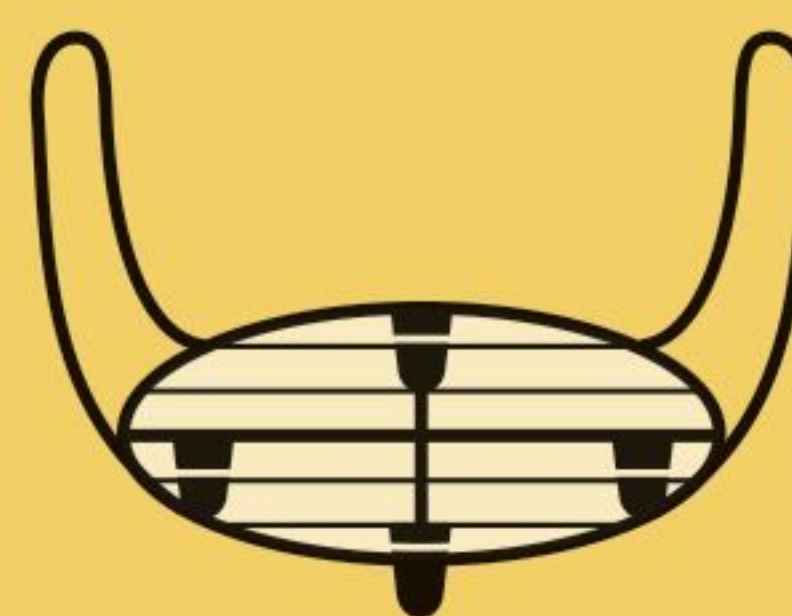

"This rack, which has a locking-rim design to secure other accessories to it (such as the cake pan, above right), is a game-changer," Santanachote said. It holds food high out of the water during steaming, and its long handles make it easy to lower and lift dishes in and out of the pot.



Yogurt Maker Cups, Set of 5
\$8



"Yogurt made in the stainless steel insert can taste a bit metallic," Santanachote said. But when you pour milk straight into these plastic half-cup cups, it turns into yogurt without the mess of sterilizing milk directly in the pot. Then just put the cups in the fridge. (Some cups thickened more than others.)

*This accessory works only with some 6-quart Instant Pot models.

BUYING GUIDE





APPLIANCES

- 26 Refrigerators
- 40 Ranges
- 50 Cooktops
- 58 Wall Ovens

- 62 Microwaves
- 70 Dishwashers

DESIGN ELEMENTS

- 78 Cabinets
- 84 Countertops
- 90 Flooring

By the Numbers

Each year, Consumer Reports spends \$27 million testing, rating, and reviewing products in our 63 state-of-the-art labs.

3 Million

The number of CR members we invite in a typical year to participate in our product reliability and satisfaction surveys

2,400

The number of cookies our testers bake to evaluate the ranges and ovens in our tests

5.4 Million

How many temperature readings we take when evaluating each refrigerator in our tests

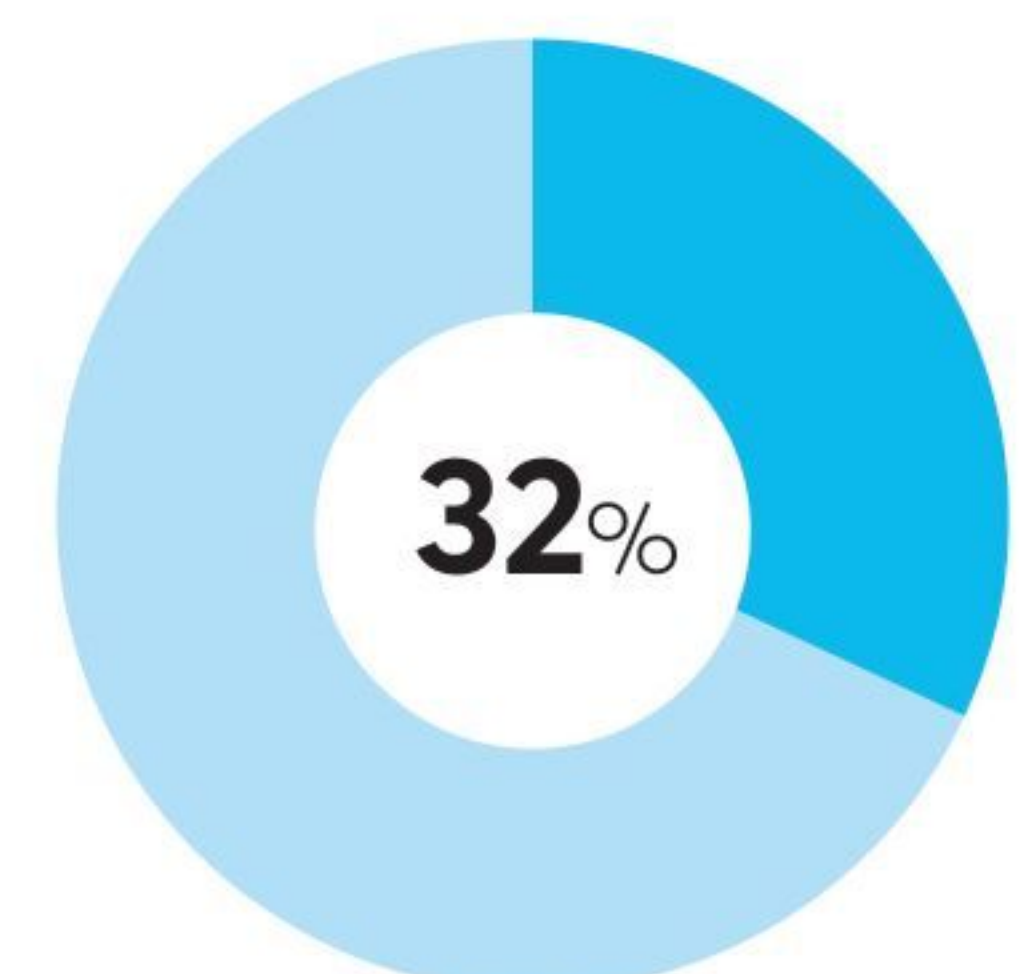

How much some refrigerators fall short of their manufacturers' capacity claims, according to CR's measurements of usable capacity.





Refrigerators

Fresh Fridges

WITH MORE CONFIGURATIONS AND OPTIONS THAN EVER, TODAY'S REFRIGERATORS ARE MADE TO SUIT YOUR FOOD-STORAGE STYLE. HERE'S HOW TO MAKE SENSE OF ALL THE CHOICES TO FIND THE BEST FIT FOR YOUR FAMILY.

Today's refrigerator features go far beyond simply providing a glass of ice water without having to open the door. With custom panels, you can get a built-in that matches your kitchen cabinets exactly. And forget about two doors—some models have five. Our fridge-by-fridge guide helps you choose the right type for your family, demystifies claimed vs. usable storage space, and helps you find the quietest models so that you—and your groceries—can chill out.

● MAKING THE RIGHT CHOICE

Think about the size and type that will work best for you. Focus on interior storage features, too.

SIZE

Refrigerator configurations come in a range of sizes (our ratings on page 32 are now arranged by width) and capacities. Always measure where you plan to put the fridge before you shop. And check that any model you consider can fit through doorways and hallways leading to your kitchen. Allow room for the refrigerator's doors to swing open and for a 1-inch clearance around sides and back for adequate airflow.

STYLE

French-door models have exploded in popularity in recent years. Bottom-freezers also offer the convenience of fresh food at eye level. But top-freezers and side-by-sides can make efficient use of space in a smaller kitchen.

CAPACITY

Most manufacturers recommend 19 to 22 cubic feet for a refrigerator that serves a family of four. But if you do a big weekly shopping trip or buy in bulk, you may need more—up to 30 to

33 cubic feet. Our tests have found that the amount of usable storage capacity is often less than the amount claimed by the manufacturer. Check our ratings on page 32 for the real story.



● FEATURES THAT MATTER MOST

Models at all prices are increasingly tricked out with a wide range of features. Here are the ones we think add the most convenience and help keep food freshest.

THROUGH-THE-DOOR ICE AND WATER DISPENSER

This is one of the conveniences most requested by consumers. But beware: Our surveys

have found that it's one of the most problematic features. It increases energy costs, too, and in side-by-sides you lose space in the freezer.

FRESHNESS FEATURES

Dual evaporators help maintain higher humidity levels in the refrigerated areas and prevent freezer odors from migrating. Air purifiers

eliminate bacteria and mold, and vacuum-sealed crisper drawers may keep food fresher.

TEMPERATURE CONTROLS

You decide how cold your fridge is in certain areas. For example, set a drawer to be cooler than the rest of the fridge to store meat, fish, and cold cuts.

BETTER SHELVES AND DRAWERS

You can rearrange split shelves to different heights independently and adjust door bins to fit taller items. But if your door has deep storage bins meant for eggs, milk, or butter, know that these items will stay fresher on internal shelves, where the temperatures are cooler. Elevator shelves



crank up and down without needing to be unloaded. Pullout shelves and bins make access to stored items easier.

DOOR-IN-DOOR STORAGE ACCESS

This feature—typically available on French-door models—lets you grab items without opening the entire door, which can reduce energy use.



MONEY SAVER

No need to pay more for digital controls or WiFi-connectivity. And consider skipping an ice maker: It adds to the upfront price and can be repair-prone.

● WHAT'S ON THE MARKET?

Here's a look at the different configurations you'll find. See our full refrigerator ratings to find out how models in different sizes and styles performed in our tests.

TOP-FREEZER

These traditional refrigerators are good for a lot of storage in a fairly tight spot. They tend to offer the most space for their size (widths vary from 28 to 33 inches). Manufacturers claim capacities of up to 23 cubic feet, but our tests have found that average usable capacity is about 17 percent less. Allow for a wide swing of the doors, and get used to crouching down to reach lower shelves and drawers.

BOTTOM-FREEZER

These range from 24 to 36 inches wide, and claimed capacities approach 30 cubic feet, though average usable space is less than that of comparable top-freezers (and top-freezers cost less). Instead of the freezer (which you use less) being at eye level, the refrigerator shelves are easily scannable. Just get used to bending to rifle through frozen goods.

FRENCH-DOOR

It has two narrow doors on top and a freezer below. Sometimes there's one drawer (or more) in between. Widths range from 30 to 36 inches. Claimed capacities go up to 34 cubic feet, though the average usable space is much less, at about 17 cubic feet. The

space-saving small-swing doors have the added value of letting you open only half of the fridge when stashing smaller items.

SIDE-BY-SIDE

The fridge is on one side and the freezer on the other, and these models usually have through-the-door ice and water dispensers. Widths are typically 33 to 36 inches, and capacity is claimed to be up to 30 cubic feet (but only about 70 percent is usable). Narrow doors are a plus for small kitchens, but they don't open wide enough for, say, a pizza box. And tall, narrow compartments make items at the back hard to find. Overall, they're not as energy- or space-efficient as other types.

BUILT-IN

Pricy and made to fit almost flush with cabinets and counters, these sleek beauties come in bottom-freezer, side-by-side, and French-door styles. They're usually wide (30 to 48 inches) with a capacity of up to 27 cubic feet (of which only about 70 percent is usable). Look for optional front panels to match your kitchen cabinets.

Or get the look for a little less with freestanding counter-depth versions. Another built-in option: an all-refrigerator column model, as narrow as 18 inches, to make the most of a kitchen nook.

Recommended Products

Most models we tested chill and freeze adequately and include pullout shelves or bins, split shelves, spill guards, and roomy storage on the door. Top-scoring models usually deliver more consistent temperatures. Once you know how much space you have, particularly the width, look at our recommended models to find ones that fit your needs. Fridges that have higher energy-efficiency scores use less electricity for their capacity. And if your household isn't large, remember that a smaller conventional refrigerator is likely to use less electricity overall than a larger model.

TOP-FREEZER



28 INCH & NARROWER WIDTHS

BLOMBERG BRFT1522SS
68Hx28Wx26D
\$900

75

Our top 28-inch-wide model, this is a very good refrigerator that's rated Excellent for thermostat control and Very Good for temperature uniformity and energy efficiency. It's also quiet. But ice making and crisper performance are rated Poor. blomberg.com



29-30 INCH WIDTHS

FRIGIDAIRE GALLERY FGTR2037TF
70Hx30Wx33D
\$920

78

A top model in our ratings, this fridge is Very Good overall. Thermostat control, temperature uniformity, and energy efficiency are rated Excellent, and noise performance earns a Good. But it fared poorly in our ease-of-use tests. frigidaire.com



31 INCH & WIDER WIDTHS

LG LTCS24223S
69Hx33Wx32D
\$1,080

77

Very Good scores for thermostat control and noise performance and Excellent for energy efficiency lift this fridge to the top of our ratings. It earns a Good rating for temperature uniformity. The trade-offs are Poor crisper and ease-of-use scores. lg.com

BOTTOM-FREEZER



30 INCH & NARROWER WIDTHS

GE GDE21ESKSS
70Hx30Wx35D
\$1,615

77

Superb thermostat control and temperature uniformity help this model, at 14.6 cubic feet (usable), earn a top spot on our recommended list. It's very quiet, and had middling energy efficiency. Crisper performance is Fair and icemaking is Poor. ge.com



31-33 INCH WIDTHS

LG LRDCS2603S
69Hx33Wx33D
\$1,200

81

This model has 17.4 cubic feet of total usable capacity. It earns Excellent scores for temperature performance, and has Very Good energy efficiency. Noise performance and ease-of-use were both Good, but crisper performance was Poor. lg.com



31-33 INCH WIDTHS

AMANA ABB2224BRM
66Hx30Wx31D
\$1,495

80

This bottom-freezer refrigerator is rated Excellent for thermostat control, temperature uniformity, and crisper performance, and Very Good for energy efficiency. Noise performance is rated Good. It has spillproof shelves and digital controls. amana.com

THREE-DOOR FRENCH-DOOR



30 INCHES & NARROWER WIDTHS

LG LFCS22520S
68Hx30Wx33D
\$1,100

78

This LG is quiet, energy-efficient, and temperature-accurate. It offers 15.4 cubic feet of usable capacity, spillproof shelves, an icemaker, gallon storage on the door, and touchpad controls.
lg.com



31-33 INCH WIDTHS

WHIRLPOOL WRF532SMHZ
69Hx33Wx32D
\$2,060

75

With 15.2 cubic feet of usable capacity, this model boasts Excellent temperature performance and energy efficiency and Very Good noise performance. It has an icemaker, spillproof shelves, and digital controls.
whirlpool.com



34 INCHES AND WIDER

LG LRFXC2406S
71Hx36Wx29D
\$3,400

84

This model has Excellent thermostat control, temperature uniformity, and noise performance, and has 15.7 cubic feet of usable capacity. Energy efficiency is rated Good. It features dual evaporators and an external water dispenser.
lg.com



34 INCHES AND WIDER

LG LMXS28626S
70Hx36Wx34D
\$2,610

77

It's not one of our recommended models, but this is one of the best four-door styles we tested. It's quiet, and has Excellent temperature performance, Good energy efficiency, and a roomy 18.1 cubic feet of usable capacity.
lg.com

SIDE-BY-SIDE



31-33 INCH WIDTHS

GE GSS23HSHSS
70Hx33Wx33D
\$1,950

71

Excellent thermostat control helped this model rise to the top of the pack. Temperature uniformity and energy efficiency are both Very Good and noise performance and icemaking are both Good. It has 15.2 cubic feet of usable space.
ge.com



34 INCHES AND WIDER

GE PROFILE PSS28KSHSS
70Hx36Wx33D
\$2,160

79

This impressive side-by-side model has 17 cubic feet of usable capacity and offers outstanding thermostat control. Temperature uniformity and energy efficiency are rated Very Good. It's extremely quiet and offers Excellent ice making.
ge.com



34 INCHES & WIDER

LGLSXS26366S
69Hx36Wx34D
\$1,620

77

This fridge has a door-within-a-door design, so you can access a portion of the fresh-food section without opening the entire door. Thermostat control is rated Excellent, temperature uniformity and energy efficiency are rated Very Good.
lg.com

BUILT-IN



THERMADOR FREEDOM COLLECTION PROFESSIONAL SERIES T36BT920NS REFRIGERATOR
84Hx36Wx25D
\$9,300

82

Our top built-in model is impressive, with Excellent thermostat control and noise performance and Very Good temperature uniformity. Energy efficiency is rated Good.
thermador.com

Brand + Model	Overall Score	Price	Survey Results		Test Results					Features							
			Predicted reliability	Owner satisfaction	Thermostat control	Temperature uniformity	Energy efficiency	Noise	Ease of use	Cabinet-depth model	Exterior height (in.)	Exterior width (in.)	Exterior depth (in.)	Total usable capacity (cu. ft.)	Energy cost/yr. (\$)	Stainless/SS-look option	Energy star

TOP FREEZERS (31 INCH AND WIDER WIDTHS)

✓ LG LTCS24223S	77	\$1,080	↑	↑	↑	↓	↑	↑	↓		69	33	32	19.3	65	•	•	•	
✓ Samsung RT21M6213SG	77	\$1,100	↑	↓	↑	↓	↑	↑	↓		68	33	32	20.2	51	•	•		
✓ Samsung RT21M6215SG	76	\$1,100	↑	↓	↑	↓	↑	↑	↓		68	33	32	20.2	62	•	•	•	
✓ Maytag MRT311FFFM	72	\$1,050	↑	↓	↑	↑	↑	↓	↓		66	33	31	17.5	56	•		Opt.	
✓ GE GTS21FSKSS	69	\$1,010	↑	↓	↑	↑	↑	↓	↓		67	32	32	17.6	56	•		Opt.	
Whirlpool WRT511SZDM	66	\$1,020	↑	↓	↓	↓	↑	↑	↓		66	33	32	18.1	57	•		Opt.	
Kenmore 79433	64	\$1,100	↑	↓	↓	↓	↑	↑	↓		69	33	32	19.4	71	•	•	•	Int.
GE GIE21GSHSS	63	\$1,255	↑	↓	↓	↑	↑	↑	↓		67	33	33	17.7	62	•	•	•	
Insignia NS-RTM21SS7	61	\$775	–	–	↓	↓	↑	↓	↓		67	33	34	18	51	•	•	•	
Whirlpool WRT311FZDW	50	\$950	↑	↓	↓	↑	↑	↓	↓		66	33	32	15.8	56	•		Opt.	
Whirlpool WRT541SZDM	45	\$1,070	↑	↓	↓	↓	↑	↑	↓		66	33	32	18.1	51	•	•	Opt.	
Kenmore 71212	40	\$785	↑	↓	↓	↓	↑	↓	↓		67	33	29	17.8	61	•	•	•	

TOP FREEZERS (29-30 INCH WIDTHS)

✓ Frigidaire Gallery FGTR2037TF	78	\$920	↑	↓	↑	↑	↑	↓	↓		70	30	33	16.7	55	•		Opt.	
✓ Samsung RT18M6215SG	76	\$800	↑	↓	↑	↑	↑	↑	↓		67	29	29	13.6	58	•	•	•	
Ⓢ Insignia NS-RTM18BK8Q	75	\$550	–	–	↑	↑	↑	↓	↓		67	30	31	15.5	51	•		Opt.	
✓ Frigidaire Gallery FGTR1837TF	71	\$695	↑	↓	↑	↑	↑	↓	↓		66	30	31	15.2	47	•	•	Opt.	
✓ Frigidaire FFTR2021TS	71	\$900	↑	↓	↑	↑	↑	↓	↓		69	30	33	16.7	55	•		Opt.	
Frigidaire FFHT1821TS	66	\$850	↑	↓	↑	↑	↑	↓	↓		64	30	30	14.2	47	•	•	Opt.	
GE GTS17GSNRSS	64	\$710	↑	↓	↑	↑	↑	↓	↓		65	28	31	12.9	51	•		Opt.	
Maytag MRT118FFFZ	56	\$830	↑	↓	↓	↓	↑	↓	↓		66	30	32	15.3	53	•		Opt.	
Amana ART104TFDW	55	\$600	↑	↓	↓	↓	↑	↓	↓		63	28	30	12.4	48	•		Opt.	
Insignia NS-RTM18SS7	52	\$680	–	–	↓	↑	↑	↓	↓		67	30	32	15.1	47	•	•	•	
Frigidaire FFHT1621TW	51	\$680	↑	↓	↓	↑	↑	↓	↓		66	29	31	13.5	45	•	•	Opt.	
Whirlpool WRT519SZDM	50	\$855	↑	↓	↓	↑	↑	↑	↓		66	30	33	16	54	•		•	
GE GTE18GMHES	48	\$820	↑	↓	↓	↓	↑	↓	↓		67	28	31	13.4	46	•	•	Opt.	
Whirlpool WRT318FMMD	41	\$840	↑	↓	↓	↓	↑	↑	↓		66	30	33	15.1	64	•		•	

Brand + Model	Overall Score	Price	Survey Results		Test Results					Features							
			Predicted reliability	Owner satisfaction	Thermostat control	Temperature uniformity	Energy efficiency	Noise	Ease of use	Cabinet-depth model	Exterior height (in.)	Exterior width (in.)	Exterior depth (in.)	Total usable capacity (cu. ft.)	Energy cost/yr. (\$)	Stainless/SS-look option	Energy star

TOP FREEZERS (28 INCH AND NARROWER WIDTHS)

	Blomberg BRFT1522SS	75	\$900	—	—							68	28	26	12	52	•	•	•	
	Hotpoint HPS16BTNRWW	71	\$580									62	28	30	12.4	50				Opt.
	Whirlpool WRT518SZFM	69	\$745									68	28	31	14.9	52	•			Opt.
	Hotpoint HPE15BTHWW	56	\$625									62	28	30	11.6	43		•		Opt.
	Hotpoint HPS15BTHLWW	54	\$605									62	28	30	11.6	48				Opt.
	Whirlpool WRT106TFDW	53	\$620									66	28	32	12.9	50				Opt.
	Frigidaire FFTR1514TW	52	\$620									61	28	30	13.8	48				Opt.
	GE GIE18GSHSS	52	\$840									67	28	31	13.9	57	•	•	•	
	GE GTE16GTHWW	48	\$740									65	28	30	11.9	44			•	Opt.
	Danby DFF101B2WDB	46	\$670	—	—							60	24	26	8.3	38	•	•		
	Galanz GLR12TRDEFR	43	\$655	—	—							67	24	29	10.5	40	•	•		NA

BOTTOM FREEZERS (31-33 INCH WIDTHS)

	LG LRDCS2603S	81	\$1,200									70	33	33	17.4	72	•	•	•	
	GE GDE25ESKSS	80	\$1,900									69	33	35	17.1	79	•	•	•	
	Amana ABB2224BRM	80	\$1,430									69	33	31	15.3	59	•	•	•	
	KitchenAid KRBR102ESS	74	\$1,930									69	33	31	14.9	75	•	•	•	
	Whirlpool WRB322DMBM	73	\$1,440									69	33	31	14.9	75	•	•	•	
	Fisher & Paykel ActiveSmart RF170WDRUX5	72	\$2,600								•	68	32	28	13	69	•	•	•	Ext.
	Hisense HBM17158SS	63	\$900	—	—						•	70	32	27	13.7	58	•			NA

BOTTOM FREEZERS (30 INCH AND NARROWER WIDTHS)

	GE GDE21ESKSS	77	\$1,615									70	30	35	14.6	74	•	•	•	
	Amana ABB1924BRM	77	\$1,495									66	30	31	12.5	58	•	•	•	
	Bosch B11CB50SSS	70	\$2,395	—	—						•	79	24	26	8.4	46	•	•	•	
	Haier HRB15N3BGS	70	\$1,095	—	—						•	68	28	24	11.9	55	•	•		
	Blomberg BRFB1822SSN	67	\$1,600	—	—							60	30	31	13.7	68	•	•	•	
	GE GLE12HSLSS	61	\$1,525								•	70	24	26	7.7	52	•	•		
	Whirlpool URB551WNGZ	58	\$1,255								•	74	24	27	8.4	51	•	•		

Brand + Model	Overall Score	Price	Survey Results		Test Results					Features							
			Predicted reliability	Owner satisfaction	Thermostat control	Temperature uniformity	Energy efficiency	Noise	Ease of use	Cabinet-depth model	Exterior height (in.)	Exterior width (in.)	Exterior depth (in.)	Total usable capacity (cu. ft.)	Energy cost/yr. (\$)	Stainless/SS-look option	Energy star

BOTTOM FREEZERS (30 INCH AND NARROWER WIDTHS) *Continued*

Blomberg BRFB1522SS	40	\$1,800	–	–	⬇	⬇	⬆	⬆	⬇	•	76	28	28	14.7	68	•	•	•	
Summit FFBF287SSIM	40	\$1,690	–	–	⬇	⬇	⬆	⬆	⬇	•	76	28	27	14.5	68	•	•	•	

FRENCH DOORS (34 INCH AND WIDER WIDTHS)

✓ LG LRFXC2406S	84	\$3,400	⬆	⬆	⬆	⬆	⬆	⬆	⬆		71	36	29	15.7	88	•	•	•	Ext.
✓ LG LRFDS3006S	83	\$3,800	⬆	⬆	⬆	⬆	⬆	⬆	⬆		71	36	34	20.5	94	•	•	•	Ext.
✓ LG LNXS30866D	81	\$4,100	⬆	⬆	⬆	⬆	⬆	⬆	⬆		69	36	37	21.7	99	•	•	•	Ext.
✓ LG LRFDS3016S	81	\$3,200	⬆	⬆	⬆	⬆	⬆	⬆	⬆		70	36	33	20.4	97	•	•	•	Ext.
GE Profile PYE22PSKSS	80	\$2,660	⬆	⬆	⬆	⬆	⬆	⬆	⬆	•	70	36	30	15.1	86	•	•	•	Ext.
GE GYE22HSKSS	80	\$3,130	⬆	⬆	⬆	⬆	⬆	⬆	⬆	•	70	36	30	15.1	86	•	•	•	Ext.
Dacor DRF36C100SR	80	\$4,000	–	–	⬆	⬆	⬆	⬆	⬆		69	36	31	14.3	71	•	•	•	Ext.
Café CYE22TSHSS	80	\$3,200	⬆	⬆	⬆	⬆	⬆	⬆	⬆	•	70	36	30	15.1	86	•	•	•	Ext.
LG LRFVS3006S	79	\$4,000	⬆	⬆	⬆	⬆	⬆	⬆	⬆		70	36	33	19.6	99	•	•	•	Ext.
LG LFXS28968S	77	\$2,430	⬆	⬆	⬆	⬆	⬆	⬆	⬆		70	36	34	19.4	94	•	•	•	Ext.
LG LFCS27596S	77	\$1,600	⬆	⬆	⬆	⬆	⬆	⬆	⬆		70	36	33	19.8	82	•	•	•	
LG LMXS28626S	77	\$2,610	⬆	⬆	⬆	⬆	⬆	⬆	⬆		70	36	34	18.1	93	•	•	•	Ext.
Whirlpool WRF954CIHM	76	\$3,505	⬆	⬆	⬆	⬆	⬆	⬆	⬆	•	70	36	29	15.4	87	•	•	•	Ext.
LG LFXS24663S	76	\$3,200	⬆	⬆	⬆	⬆	⬆	⬆	⬆		70	36	32	16.7	89	•	•	•	Ext.
KitchenAid KRFC704FBS	76	\$4,140	⬆	⬆	⬆	⬆	⬆	⬆	⬆	•	71	36	29	15.3	95	•	•	•	Ext.
LG LFXS28566S	76	\$3,000	⬆	⬆	⬆	⬆	⬆	⬆	⬆		70	36	34	19.2	93	•	•	•	Ext.
Kenmore 73035	75	\$1,400	⬆	⬆	⬆	⬆	⬆	⬆	⬆		71	36	34	18.6	88	•	•	•	Ext.
LG Signature LUPXC2386N	75	\$6,300	⬆	⬆	⬆	⬆	⬆	⬆	⬆	•	70	36	30	15.5	92	•	•	•	Ext.
Café CFE28TSHSS	74	\$3,430	⬆	⬆	⬆	⬆	⬆	⬆	⬆		70	36	35	15.1	94	•	•	•	Ext.
KitchenAid KRFC302ESS	74	\$3,265	⬆	⬆	⬆	⬆	⬆	⬆	⬆	•	73	36	28	14.3	82	•	•	•	Int.
LG LMXC23796D	74	\$2,430	⬆	⬆	⬆	⬆	⬆	⬆	⬆	•	69	36	30	14.8	76	•	•	•	Ext.
GE Profile PYD22KSLSS	74	\$3,100	⬆	⬆	⬆	⬆	⬆	⬆	⬆	•	70	36	28	19.4	94	•	•	•	Ext.
Samsung RF23M8070SR	74	\$2,600	⬇	⬇	⬆	⬆	⬆	⬆	⬆	•	70	36	29	14.5	82	•	•	•	Ext.
LG LMXS27626S	73	\$1,980	⬆	⬆	⬆	⬆	⬆	⬆	⬆		69	36	33	17.6	92	•	•	•	Ext.
GE Profile PVD28BYNFS	73	\$3,520	⬆	⬆	⬆	⬆	⬆	⬆	⬆		70	36	35	17.8	100	•	•	•	Ext.

Brand + Model	Overall Score	Price	Survey Results		Test Results					Features								
			Predicted reliability	Owner satisfaction	Thermostat control	Temperature uniformity	Energy efficiency	Noise	Ease of use	Cabinet-depth model	Exterior height (in.)	Exterior width (in.)	Exterior depth (in.)	Total usable capacity (cu. ft.)	Energy cost/yr. (\$)	Stainless/SS-look option	Energy star	Icemaker

FRENCH DOORS (34 INCH AND WIDER WIDTHS) Continued

GE GFE28GYNFS	73	\$2,725	↓	↓	↑	↑	↑	↓	↑		70	36	32	19.9	94	•	•	•	Ext.
Samsung RF22K9381SR	73	\$3,000	↓	↓	↑	↑	↓	↑	↑	•	72	36	29	15.8	91	•	•	•	Ext.
Samsung RF23M8570SG	73	\$3,600	↓	↓	↑	↑	↓	↑	↑	•	70	36	29	14.3	85	•	•	•	Ext.
Daewoo RFS-26ABT	72	\$1,310	—	—	↑	↑	↑	↑	↓		70	36	34	18.9	88	•		•	
KitchenAid KRMF706EBS	72	\$3,820	↓	↓	↑	↑	↓	↑	↑		70	36	34	17.1	99	•		•	Ext.
Samsung RF28K9070SR	72	\$2,600	↓	↓	↑	↑	↑	↑	↑		71	36	35	20.4	101	•	•	•	Ext.
Kenmore 72595	72	\$2,200	↓	↓	↑	↑	↓	↑	↑		70	36	34	13.4	102	•		•	Ext.
Whirlpool WRF555SDFZ	72	\$1,980	↓	↓	↑	↑	↓	↑	↓		70	36	33	15.9	88	•	•	•	Ext.
Samsung RF28N9780SR	72	\$2,895	↓	↓	↑	↑	↑	↑	↑		72	36	34	22.4	100	•	•	•	Ext.
Insignia NS-RFD26SS9	72	\$1,200	—	—	↑	↑	↑	↑	↓		70	36	34	20.2	81	•	•	•	Int.
Samsung RF28R6201SR	72	\$2,100	↓	↓	↑	↑	↑	↑	↑		70	36	34	18.8	94	•	•	•	Ext.
Samsung RF28JBEDBSR	71	\$3,600	↓	↓	↑	↑	↓	↑	↑		70	36	34	16.8	93	•	•	•	Ext.
Samsung RF23R6201SR	71	\$2,200	↓	↓	↑	↑	↓	↑	↑	•	70	36	29	15.3	90	•	•	•	Ext.
Maytag MFI2570FEZ	71	\$2,300	↓	↓	↑	↑	↓	↑	↓		70	36	33	15.9	88	•	•	•	Ext.
Samsung RF28R7351SG	71	\$2,400	↓	↓	↑	↑	↓	↑	↑		70	36	34	18	97	•	•	•	Ext.
GE GNE27JSMSS	71	\$1,980	↓	↓	↑	↑	↑	↓	↓		70	36	34	21	82	•	•	•	Int.
Bosch B36CT80SNS	71	\$3,100	↓	↓	↑	↑	↓	↑	↑	•	72	36	29	12.6	74	•	•	•	Int.
Samsung RF265BEAESG	71	\$3,220	↓	↓	↑	↑	↑	↑	↑		70	36	34	17.3	93	•	•	•	Ext.
Bosch 800 Series B26FT50SNS	71	\$2,595	↓	↓	↑	↑	↓	↑	↓		70	36	34	17.3	89	•	•	•	Ext.
Whirlpool WRX735SDHZ	71	\$2,250	↓	↓	↑	↑	↓	↑	↓		70	36	32	16	88	•	•	•	Ext.
Samsung RF22KREDBSR	71	\$3,200	↓	↓	↑	↑	↓	↑	↑	•	70	36	29	14.9	86	•	•	•	Ext.
Samsung RF23J9011SR	71	\$2,400	↓	↓	↑	↑	↑	↑	↑	•	72	36	29	16.1	88	•	•	•	Ext.
Samsung RF28NHEDBSG	71	\$2,655	↓	↓	↑	↑	↓	↑	↑		70	36	34	18.4	96	•	•	•	Ext.
Bertazzoni Professional Series REF36X	70	\$3,080	—	—	↑	↑	↓	↑	↑	•	70	36	29	14.2	80	•		•	
LG LFXC24796D	70	\$3,020	↓	↑	↑	↑	↓	↑	↑	•	70	36	29	14.5	92	•	•	•	Ext.
Maytag MFF2558FEZ	70	\$1,855	↓	↓	↑	↑	↑	↑	↓		69	36	33	17.1	79	•	•	•	
Bosch 800 Series B21CT80SNS	69	\$2,750	↓	↓	↑	↑	↓	↑	↑	•	70	36	29	13.4	80	•		•	
Bosch B36CL80SNS	69	\$3,300	↓	↓	↑	↑	↓	↑	↑	•	72	36	29	12.9	73	•	•	•	Int.

Brand + Model	Overall Score	Price	Survey Results		Test Results					Features									
			Predicted reliability	Owner satisfaction	Thermostat control	Temperature uniformity	Energy efficiency	Noise	Ease of use	Cabinet-depth model	Exterior height (in.)	Exterior width (in.)	Exterior depth (in.)	Total usable capacity (cu. ft.)	Energy cost/yr. (\$)	Stainless/SS-look option	Energy star	Icemaker	Water dispenser
FRENCH DOORS (34 INCH AND WIDER WIDTHS) Continued																			
Bosch 800 Series B21CL81SNS	68	\$2,970	↓	↓	↑	↑	↓	↑	↓	•	70	36	29	14.3	80	•	•	•	
Samsung RF22NPEDBSR	68	\$3,510	↓	↓	↑	↑	↓	↑	↑	•	70	36	29	15	88	•	•	•	Ext.
GE GFE26JSMSS	67	\$2,500	↓	↓	↑	↑	↑	↓	↓	•	70	36	34	17.7	90	•	•	•	Ext.
KitchenAid KRFF305ESS	66	\$2,035	↓	↓	↑	↑	↑	↑	↓	•	69	36	33	17.4	79	•	•	•	Int.
Whirlpool WRF757SDHZ	65	\$2,750	↓	↓	↑	↑	↓	↓	↑	•	70	36	34	17.3	92	•	•	•	Ext.
Samsung RF27T5201SG	64	\$2,160	↓	↓	↑	↑	↓	↑	↓	•	70	36	35	18.2	91	•	•	•	Ext.
Samsung RF263BEAESR	64	\$2,220	↓	↓	↑	↑	↑	↓	↑	•	70	36	32	16.4	82	•	•	•	Ext.
Blomberg BRFD2230SS	63	\$2,550	–	–	↑	↓	↓	↑	↑	•	70	36	30	14.3	71	•	•	•	Int.
GE GYS22GSNSS	63	\$2,815	↓	↓	↑	↑	↓	↓	↑	•	70	36	29	15	94	•	•	•	Ext.
Samsung RF261BEAESR	63	\$1,650	↓	↓	↑	↑	↑	↑	↑	•	70	36	32	16.7	80	•	•	•	Int.
Frigidaire Gallery FGHN2868TF	62	\$2,225	↓	↓	↑	↑	↑	↑	↑	•	70	36	34	19.6	83	•	•	•	•
BlueStar FBFD36	62	\$3,295	–	–	↑	↓	↓	↑	↓	•	70	36	27	13.6	73	•	•	•	Int.
LG LRMD3006S	62	\$3,200	↓	↑	↓	↑	↑	↑	↑	•	70	36	37	27.8	103	•	•	•	Ext.
KitchenAid KRFC300ESS	60	\$2,160	↓	↓	↑	↑	↓	↑	↓	•	69	36	28	13.6	73	•	•	•	Int.
Maytag MFC2062FEZ	60	\$2,400	↓	↓	↑	↑	↓	↑	↓	•	69	36	28	13.6	73	•	•	•	Int.
Fisher & Paykel ActiveSmart RF201ADUSX5	60	\$2,950	↓	↓	↓	↓	↑	↑	↓	•	71	36	28	14.4	69	•	•	•	Ext.
Frigidaire Gallery FGHB2868TF	59	\$2,120	↓	↓	↑	↑	↑	↑	↑	•	70	36	34	18	92	•	•	•	Ext.
Viking RVRF3361SS	59	\$3,560	↓	↓	↑	↑	↓	↑	↑	•	70	36	27	13.6	83	•	•	•	•
Frigidaire Gallery FGHG2368TF	57	\$2,515	↓	↓	↑	↑	↓	↑	↓	•	70	36	29	15.5	76	•	•	•	•
Frigidaire FG4H2272UF	56	\$2,880	↓	↓	↑	↑	↓	↑	↑	•	70	36	31	15	87	•	•	•	Ext.
Frigidaire Gallery FGHD2368TF	55	\$2,950	↓	↓	↑	↑	↓	↑	↑	•	70	36	29	13.9	85	•	•	•	Ext.
Kenmore 73105	55	\$2,200	↓	↓	↓	↑	↓	↑	↑	•	70	36	34	19.1	102	•	•	•	Ext.
Electrolux IQ-Touch EI23BC82SS	48	\$3,005	↓	↓	↑	↑	↓	↑	↑	•	70	36	29	15.9	83	•	•	•	•
Electrolux IQ-Touch EI23BC32SS	48	\$2,430	↓	↓	↑	↑	↑	↓	↑	•	70	36	29	15.9	85	•	•	•	•
Electrolux Wave-Touch EW23BC87SS	45	\$3,245	↓	↓	↑	↑	↓	↓	↑	•	69	36	29	14.3	93	•	•	•	Ext.
Smeg FTU171X7	39	\$3,000	–	–	↓	↓	↓	↑	↑	•	70	36	33	16.9	88	•	•	•	Ext.
Whirlpool WRF550CDHZ	37	\$3,195	↓	↓	↑	↑	↓	↓	↓	•	70	36	28	11.6	89	•	•	•	Ext.

Brand + Model	Overall Score	Price	Survey Results		Test Results					Features							
			Predicted reliability	Owner satisfaction	Thermostat control	Temperature uniformity	Energy efficiency	Noise	Ease of use	Cabinet-depth model	Exterior height (in.)	Exterior width (in.)	Exterior depth (in.)	Total usable capacity (cu. ft.)	Energy cost/yr. (\$)	Stainless/SS-look option	Energy star

FRENCH DOORS (31-33 INCH WIDTHS)

Whirlpool WRF532SMHZ	75	\$2,060									69	33	32	15.2	59				
GE GNE25JSKSS	75	\$1,710									69	33	35	16.4	79				Int.
GE GFE24JSKSS	74	\$2,500									70	33	36	15.2	88				Ext.
Samsung RF20HFENBSR	72	\$1,370									71	33	31	14.8	80				
LG LRFXS2503S	71	\$2,700									70	33	36	16.9	89				Ext.
Samsung RF18HFENBSR	69	\$1,250									70	32	27	13.9	77				
Haier HRQ16N3BGS	68	\$1,450									71	33	27	12.5	58				
GE GWE19JSLSS	66	\$1,710									70	33	28	12.2	71				
Frigidaire FFBN1721TV	57	\$1,050									70	33	30	13.9	65				
GE GYE18JBLTS	53	\$2,240									70	33	28	11.2	79				Ext.

FRENCH DOORS (30 INCH AND NARROWER WIDTHS)

LG LFC22770ST	81	\$1,635									68	30	33	15.4	76				
LG LFCS22520S	78	\$1,100									68	30	33	14.8	76				
GE GNE21FSKSS	75	\$1,585									70	30	35	13.7	74				
KitchenAid KRFF300ESS	74	\$1,915									73	36	28	14.3	82				Int.
Samsung RF220NCTASR	66	\$1,500									67	30	34	16	81				
Haier HRF15N3AGS	62	\$1,250									71	28	27	11.2	63				
Whirlpool WRF560SMHZ	58	\$1,600									68	30	33	13.3	72				Ext.

SIDE BY SIDES (34 INCH AND WIDER WIDTHS)

GE Profile PSS28KSHSS	79	\$2,160									70	36	33	17	95				Ext.
LG LSXS26366S	77	\$1,620									70	36	33	20.9	92				Ext.
GE Profile PSE25KSHSS	75	\$1,980									70	36	33	16.1	83				Ext.
LG LSXS26326S	74	\$1,350									69	36	34	20.6	92				Ext.
KitchenAid KRSC503ESS	74	\$3,100									71	36	28	16.2	88				
Samsung RS25J500DSR	73	\$1,220									69	36	34	18.5	90				Ext.
Kenmore Elite 51863	72	\$2,000									70	36	30	16.2	78				Ext.
Kenmore 51783	71	\$1,500									69	36	29	14.6	84				Ext.
Daewoo FRS-Y22D2T	70	\$1,280									70	36	28	14.9	83				Ext.
Samsung RS27T5561SR	70	\$1,980									70	36	33	20.1	89				Ext.

Brand + Model	Overall Score	Price	Survey Results		Test Results					Features									
			Predicted reliability	Owner satisfaction	Thermostat control	Temperature uniformity	Energy efficiency	Noise	Ease of use	Cabinet-depth model	Exterior height (in.)	Exterior width (in.)	Exterior depth (in.)	Total usable capacity (cu. ft.)	Energy cost/yr. (\$)	Stainless/SS-look option	Energy star	Icemaker	Water dispenser
SIDE BY SIDES (34 INCH AND WIDER WIDTHS) Continued																			
✓ GE Profile PZS22MSKSS	70	\$2,790	↓	↓	↑	↓	↓	↑	↑	•	70	36	29	13.8	86	•	•	•	Ext.
LG LRSES2706V	69	\$1,530	↓	↓	↑	↓	↑	↑	↑		70	36	34	20.6	87			•	
Whirlpool WRS586FIEM	69	\$1,690	↓	↓	↑	↓	↑	↑	↑		69	36	33	18.9	83	•	•	•	Ext.
Frigidaire FFSS2625TS	68	\$1,255	↓	↓	↑	↑	↑	↓	↓		70	36	32	17.4	91	•		•	Ext.
Whirlpool WRS588FIHZ	68	\$1,600	↓	↓	↑	↓	↑	↑	↑		69	36	33	20.5	96	•		•	Ext.
GE GZS22IYNFS	68	\$1,900	↓	↓	↑	↑	↓	↓	↑	•	70	36	28	14.5	86	•		•	Ext.
Frigidaire FGSS2635TF	67	\$1,405	↓	↓	↑	↑	↑	↓	↑		70	36	34	18.5	91	•		•	Ext.
Kenmore Elite 51773	67	\$2,000	↓	↓	↑	↓	↑	↑	↑		69	36	34	21.8	95	•		•	Ext.
GE GSS25GSHSS	67	\$1,440	↓	↓	↑	↓	↑	↓	↑		70	36	33	16.3	91	•		•	Ext.
GE GSS25LSLSS	66	\$1,440	↓	↓	↑	↓	↑	↓	↑		70	36	34	17.3	91	•		•	
Samsung RS22T5561SR	66	\$2,070	↓	↓	↑	↑	↓	↑	↓	•	70	36	28	16.1	82	•	•	•	Ext.
KitchenAid KRSC703HPS	65	\$3,100	↓	↓	↑	↑	↓	↑	↑	•	72	35	27	14	88	•	•	•	Ext.
Frigidaire FGSC2335TF	64	\$1,700	↓	↓	↑	↓	↑	↓	↑	•	70	36	29	16	87	•		•	Ext.
Kenmore 51335	64	\$1,400	↓	↓	↑	↑	↑	↓	↓		70	36	32	10.8	90	•		•	Ext.
Whirlpool WRS325SDHZ	63	\$1,350	↓	↓	↓	↑	↑	↓	↓		69	36	33	15.1	90	•	•	•	Ext.
Whirlpool WRS325FDAM	63	\$1,050	↓	↓	↓	↑	↑	↓	↓		69	36	33	15.1	90	•	•	•	Ext.
Bosch 300 Series B20CS30SNS	62	\$2,025	↓	↓	↑	↑	↑	↑	↓	•	70	36	28	14.5	76	•	•	•	Ext.
Samsung RS22T5201SR	62	\$1,350	↓	↓	↑	↓	↑	↑	↑	•	70	36	29	17.1	83	•	•	•	Ext.
Maytag MSC21C6MFZ	61	\$1,665	↓	↓	↑	↓	↓	↑	↑	•	69	36	28	14.1	84	•		•	Ext.
GE GSS25IYNFS	61	\$1,620	↓	↓	↑	↓	↑	↓	↑		70	36	32	17	91	•		•	Ext.
Whirlpool WRS555SIHZ	59	\$1,350	↓	↓	↓	↑	↑	↓	↓		70	36	32	17.7	90	•		•	Ext.
GE GZS22DSJSS	58	\$2,335	↓	↓	↑	↓	↓	↑	↓	•	70	36	27	14	86	•		•	Ext.
Blomberg BSBS2230SS	56	\$2,000	–	–	↓	↓	↑	↑	↑	•	72	36	29	14.8	75	•	•	•	Ext.
Whirlpool WRS315SNHM	55	\$1,170	↓	↓	↓	↑	↑	↓	↓		70	36	32	17.5	74	•		Opt.	
Kenmore 41173	54	\$1,100	↓	↓	↓	↑	↑	↓	↓		70	36	32	17.5	74	•		Opt.	
Maytag MSS25N4MKZ	54	\$1,050	↓	↓	↓	↑	↑	↓	↓		70	36	32	17.5	74	•		Opt.	
Whirlpool WRS315SDHM	54	\$950	↓	↓	↓	↑	↑	↓	↓		70	36	32	16.4	91	•		•	Ext.
Amana ASI2575GRS	45	\$1,000	↓	↓	↓	↑	↑	↓	↓		70	36	32	16.8	91	•		•	Ext.

Brand + Model	Overall Score	Price	Survey Results		Test Results					Features							
			Predicted reliability	Owner satisfaction	Thermostat control	Temperature uniformity	Energy efficiency	Noise	Ease of use	Cabinet-depth model	Exterior height (in.)	Exterior width (in.)	Exterior depth (in.)	Total usable capacity (cu. ft.)	Energy cost/yr. (\$)	Stainless/SS-look option	Energy star

SIDE BY SIDES (31-33 INCH WIDTHS)

GE GSS23HSHSS	71	\$1,695									70	33	33	15.2	87				Ext.
Whirlpool WRS321SDHZ	63	\$1,260									67	33	32	12.7	85				Ext.
Amana ASI2175GRS	63	\$1,090									67	33	32	12.7	85				Ext.
GE GSE23GSKSS	60	\$1,580									69	33	33	14.1	79				Ext.
Whirlpool WRS331SDHM	60	\$1,330									67	33	32	13.7	78				Ext.

BUILT-INS

Thermador Freedom Collection Professional Series T36BT920NS	82	\$9,300									84	36	25	13.3	75				
Dacor DRF427500AP	81	\$11,000	-	-							85	42	25	16.6	81				Int.
Thermador Freedom Collection T36IT901NP	81	\$8,000									84	36	25	12.7	75				
Dacor DRF367500AP	80	\$8,600	-	-							84	36	24	14.6	71				Int.
Jenn-Air JF42NXFXDE	79	\$9,400									83	42	26	17	82				
Jenn-Air JB36NXFXRE	78	\$7,400									83	36	26	14.9	77				
KitchenAid KBFN502ESS	78	\$8,930									83	42	26	17	82				
KitchenAid KBBR306ESS	76	\$6,900									83	36	26	14.9	77				
GE Monogram ZIPP360NHSS	72	\$8,600									84	36	26	14	85				
Miele PerfectCool KFNF9955IDE	71	\$7,100									80	36	24	13.6	72				
Café CSB42WP2NS1	70	\$7,140									84	42	26	19.5	99				
Miele KFN9855IDE	69	\$5,600									80	36	25	13.7	55				
Blomberg BRFB1920SS	69	\$5,665	-	-							84	30	25	12.8	72				
Liebherr CBS2062	66	\$6,420									80	36	25	13.9	68				
Fisher & Paykel RS36W80J	64	\$6,000	-	-							80	36	24	12.1	69				
Viking VCB5363ERSS	45	\$9,480									83	35	24	15.3	78				
Viking VCSB5423SS	45	\$9,890									83	42	26	18.3	91				
Viking Professional 7 Series VBI7360WRSS	35	\$10,500									84	36	25	14.6	77				

HOW WE TEST: Overall Score combines test results with survey data for predicted reliability and owner satisfaction. Predicted reliability estimates the likelihood that newly purchased models from a given brand will develop problems or break within the first five years. Owner satisfaction reflects the

proportion of CR members who are extremely likely to recommend the refrigerator they bought. In cases where we have insufficient survey data to provide a brand-level rating, indicated by a gray dash (-), we give the model weighted category average scores for reliability and satisfactions.

Thermostat control assesses the ability to reach and maintain a set temperature despite changes in room temperature. **Temperature uniformity** is the ability to mitigate warm and cold spots in the fridge and freezer compartments. **Energy efficiency** indicates energy consumption based

on usable storage space and the national average electricity cost. **Noise** reflects quietness of operation based on noise meter readings and a panel of listeners. **Ease of use** assesses lay-out and features. **Price** is approximate retail.





Ranges

Range Finder

ONE OVEN OR TWO? FOUR BURNERS, FIVE, OR MORE? THIS DO-IT-ALL APPLIANCE COMES IN SIZES AND STYLES TO FIT YOUR COOKING NEEDS—AND YOU DON'T HAVE TO SPEND A FORTUNE TO GET GREAT PERFORMANCE AND CONVENIENT FEATURES.

The range is the workhorse of the kitchen, and if it's stylish, it's probably the centerpiece, too. Electric smoothtop ranges remain the best sellers, but you have more options than ever, including double-oven models for the multitasker in all of us. Electric induction ranges are coming down in price, and for gas models we've found that you can get good looks and top performance without forking over a fortune on a pro-style model. Read on to learn how.

Ranges



● MAKING THE RIGHT DECISION

Remodeling or starting from scratch? Cooking for a crowd or for just two—or one? These topics and others will help you decide what you need in a new range.

TYPE

Freestanding ranges are the most widely sold and easiest to install. The oven control panel is usually on the back panel, above the cooktop surface. But manufacturers of many new models have moved the oven controls to the front and eliminat-

ed the back panel; these models offer the same ease of installation. For a more custom, built-in look, there are slide-in models, where the cooktop rests on the counter on either side.

SIZE

Most electric and gas ranges are 30 inches wide, which is the size we buy and test. Pro-style ranges often span 36 inches or more; we test 30-inch and 36-inch models. They're big on style but aren't the best-performing ranges

we've tested. Even regular ranges now have beefy knobs, rugged grates, stainless trim, and more style for a lot less money.

CAPACITY

A roomy oven comes in handy when baking or entertaining. We measure oven space you can actually use, so check the capacity scores in our range ratings. The smallest ovens in our tests are a little more than 2 cubic feet; the largest are almost 4 cubic feet.





● FEATURES THAT MATTER MOST

Here's a look at some of the perks found on the newest models.

CONTROL LOCKOUT

It lets you disable the oven controls. We recommend it if the electronic oven control panel is at the front of the range rather than on the back panel, especially if small children are in the house.

DOUBLE OVENS

Two separate ovens let you, say, roast a turkey in one while baking pies in the other, and at different temperatures. Some ranges pair a smaller top oven with a larger oven below; others have two same-sized ovens. Keep in mind that there's no storage drawer, and usually the convection feature is in the bottom oven.

EXPANDABLE ELEMENTS, A BRIDGE, AND OVAL BURNERS

On gas cooktops, oval burners accommodate griddles and elongated pans. Certain electric rangetops have an elongated bridge element that spans two burners to fit a griddle or other odd-shaped cookware. Most electric radiant and induction smooth-tops have an expandable burner that lets you choose the size that best matches the pot's diameter.

HOT-SURFACE WARNING LIGHTS

These lights warn you when an element is still hot, and they're especially useful on electric radiant smooth-tops. Some ranges have one warning light; others have a light for each burner.

CONVECTION

Many mid- and higher-priced ranges use one fan or more to circulate hot air in the oven. Some ovens, usually electric models, have an additional convection heating element. Convection typically reduces cooking time, especially for large roasts.

VARIABLE BROIL

Most electric and gas ovens have this feature. Variable broil provides adjustable settings for foods that need slower or faster cooking.

TIMED/DELAYED START

This lets you set a time for the electric or gas oven to start and stop cooking. But this feature is not essential; it mainly buys you preheating time, and most foods shouldn't stay in a cold oven for long.



KITCHENAID

● WHAT'S ON THE MARKET?

If you have a choice of fuel type, gas and electric ranges have their advantages.

ELECTRIC SMOOTHTOP

Ranges with electric radiant smoothtops are the popular pick. All the models in our tests have at least one high-power burner. Most have

expandable dual or triple elements that let you switch from a large, high-power element to a small, lower-power element within it. Certain ranges have a warming element in the center to keep side dishes warm.

There's a lot of residual heat, so when reducing the temperature it can take a few minutes

to really settle at the lower setting.

ELECTRIC INDUCTION

Electric ranges with an induction cooktop use magnetic coils below a ceramic glass surface to quickly generate heat directly to the pan, offering precise simmering and control. You'll need magnetic cookware

for induction to work. If a magnet strongly sticks to the bottom of a pot, it will work with an induction cooktop. Certain stainless steel cookware is induction-capable.

GAS

The capacity of a burner is measured in British thermal units (Btu)

per hour. Most ranges have four surface burners in three sizes: one or two medium-power burners (about 9,000 Btu), a small burner (about 5,000 Btu), and one or two large ones (about 12,000 Btu or more). Some have a fifth burner instead of a center section. Response time for gas burners is quick, especially when compared with a radiant smoothtop. And with most gas burners, you can strike a match to light them when the power is out.



**MONEY
SAVER**

Don't Pay More for Pro-Style

Peek into the kitchen of your favorite restaurant and you're likely to see some equipment that helps the chef turn out top-tier food—warming drawers, multiple convection ovens, and plenty of burners for searing meats and simmering sauces at the same time.

You love all that beefy stainless steel! And you're thinking a pro-style range in your kitchen will have you cooking like a pro. Not so. Our experts routinely observe that pro-style ranges lag behind regular stoves in terms of performance, and many lack the very features that would help you cook like a professional chef.

"Even basic conveniences that you'd take for granted on a regular range, like a digital oven display or preheat light, are often missing on pro-style ranges," says Tara Casaregola, who oversees range testing for Consumer Reports.

While you might be willing to shrug off a few missing features, we've highlighted five here that could make you rethink the choice to go pro.



EXTRA BURNERS

It was once rare for a 30-inch range to come with more than four burners, but you can now find five on every recommended gas range in our ratings (see page 47). On the flip side, only one of the 30-inch pro-style ranges we've tested offers a fifth burner.

Some of these extra burners are of dubious value because fitting five pots would be tricky. But those with an oblong fifth burner in the center of the range-top may include a drop-in griddle that can simulate the convenience of cooking on a restaurant range's flattop.



DOUBLE OVENS

Cooking two different foods at two different temperatures simultaneously presents a challenge—unless you have two ovens. That's a feature you'll find on traditional gas and electric ranges costing under \$1,500.

None of the 30-inch pro-style ranges we've evaluated offer dual ovens, though some pro-style range manufacturers offer dual side-by-side ovens on ranges 48 inches and wider (for a hefty price).



SELF-CLEANING CYCLES

The idea of hand-scrubbing an oven seems dated, but that's often what you're signing up for with the purchase of a pro-style range. More than half the models in our ratings lack a self-cleaning setting.

On the other hand, you'll find the feature on almost every traditional range we've evaluated, even on some models that cost less than \$500. That makes it harder to justify the \$5,000 you could spend on a pro model that requires manual scrubbing.



WARMING DRAWERS

A simple warming drawer below the main oven will keep dishes, dinner rolls, or just about anything warm until you're ready to eat.

Some gas and electric ranges even provide dedicated temperature controls for the drawer, allowing you to tackle light baking. And even the most basic models offer a storage drawer for pots and pans below the oven cavity.

Pro-style ranges, on the other hand, choose form over function—none in our ratings feature a warming or storage drawer.



SPECIALTY SETTINGS

Because pro-style range manufacturers tend to roll out fewer models than mass-market brands, they're often late to the party with helpful and innovative oven settings.

Some pro-style ranges proudly eschew electronic oven displays and settings. But this means they forgo special oven programs such as slow cook, delayed start, and proofing—a handy setting that maintains temperatures in the hard-to-hit 80° F range, which is ideal for proofing breads and dough without killing the yeast.



WANT A PRO-STYLE RANGE ANYWAY?

If you can't live without the chunky commercial look, check our ratings on page 47 for top picks for pro-style ranges; page 56 for 36-inch cooktops; and page 61 for wall ovens. You'll find ratings for built-in refrigerators on page 39.

Recommended Products

These will bring a large pot of water to a fast boil, hold a big batch of sauce or chili at a low simmer, and deliver dozens of cookies that are evenly baked and browned. They all do at least an okay job broiling, and many are excellent—nice if you enjoy a good steak or burger. Ovens are large, and self-cleaning earns a Good or better rating. CR Best Buys are recommended ranges that combine impressive performance and value, and at least a Good score for reliability.

ELECTRIC SMOOTHTOP



SMOOTHTOP, SINGLE-OVEN (30-INCH)

LG
LREL6325D
\$1,200

84

This freestanding range has four cooktop elements; two are high-power. It excels at fast cooktop heat and simmering. Baking earns a Very Good rating; broiling receives an Excellent score. Oven capacity is large, and it has a convection feature. The oven can be controlled wirelessly from a smartphone. lg.com



SMOOTHTOP, DOUBLE-OVEN (30-INCH)

LG
LTE4815ST
\$2,500

82

LG ranges typically perform well on Consumer Reports' tests, and this model with two ovens notches Excellent scores on five of six tests. But it receives mediocre results for even baking. This range is one of the few that's WiFi-enabled. lg.com

ELECTRIC INDUCTION



INDUCTION (30-INCH)

LG
LSE4617ST
\$3,700

84

Overall, this range is excellent, offering superb fast cooktop heat from its highest-power burner and steady simmering. Baking earns an Excellent rating, and broiling receives a Very Good score. Self-cleaning performance is just okay, though. This range is one of the few with a warming drawer, and one of the few that's WiFi-enabled. lg.com

GAS AND DUAL-FUEL



GAS, SINGLE-OVEN (30-INCH)

SAMSUNG
NX58R5601SS
\$730

79

This freestanding gas range earns Excellent scores for low-heat cooktop performance. High-heat cooktop performance, baking, and broiling received Very Good scores. It has five burners; two are high power. The oven has five rack positions and a warming drawer. samsung.com



DUAL-FUEL, SINGLE-OVEN (30-INCH)

LG
LSD4913ST
\$2,400

77

Very Good baking and Excellent broiling scores, plus a large oven capacity, help put this model near the top of our ratings. But it earned only a Fair score for self-cleaning, and its large burner struggled to keep tomato sauce at a low simmer. It has five burners, continuous grates, and convection mode. lg.com



DUAL-FUEL, DOUBLE-OVEN (30-INCH)

LG SIGNATURE
LUTD4919SN
\$3,600

85

Top-rated, this front-control double-oven range has five surface burners, two that are high-power. High-heat cooktop performance earns a Very Good rating; baking, simmering, broiling, and self-cleaning receive Excellent ratings. lg.com



GAS, PRO-STYLE (30-INCH)

MONOGRAM
ZGP304NRSS
\$4,500

69

This range outperforms most others of its type. It has a large oven and excels at simmering. Cooktop, high; baking; broiling; and self-cleaning earn Good ratings. Predicted reliability received a Good score; owner satisfaction, an Excellent rating. monogram.com



Brand + Model	Overall Score	Price	Survey Results		Test Results						Features					
			Predicted reliability	Owner satisfaction	Cooktop, high	Cooktop, low	Baking	Broiling	Oven capacity	Self-cleaning	High-power burners	Medium-power burners	Low-power burners	Convection mode	Slide-in	Stainless steel available
ELECTRIC SMOOTHTOP, SINGLE-OVEN (30-INCH)																
✓ LG LSE4613ST	85	\$2,000	↑	↓	↑	↑	↑	↑	↑	↑	↓	2	0	2	•	•
✓ LG LREL6325D	84	\$1,200	↑	↓	↑	↑	↑	↑	↑	↑	↑	2	0	2	•	•
✓ Samsung NE58R9431ST	81	\$1,600	↓	↓	↑	↑	↑	↑	↑	↑	↑	2	0	2	•	•
✓ GE JS760SLSS	81	\$1,720	↑	↓	↑	↑	↑	↑	↑	↑	↑	2	0	2	•	•
✓ LG LRE3194BD	81	\$990	↑	↓	↑	↑	↑	↑	↑	↑	↓	2	0	2	•	•
LG LRE3060ST	80	\$700	↑	↓	↑	↑	↑	↓	↑	↑	NA	2	0	2	•	•
GE JB655SKSS	80	\$775	↑	↓	↑	↑	↑	↓	↑	↑	↑	2	0	2	•	•
Whirlpool WEE510S0FS	79	\$1,300	↑	↓	↑	↑	↑	↓	↑	↑	↑	2	0	2	•	•
Frigidaire Gallery GCRE302LAF	78	\$850	↑	↓	↑	↑	↑	↓	↑	↑	↑	2	0	2	•	•
Samsung NE59N6650SS	77	\$1,060	↓	↓	↑	↑	↑	↑	↑	↑	↑	2	0	2	•	•
Frigidaire Gallery GCRE3060AF	76	\$1,150	↑	↓	↑	↑	↑	↑	↑	↑	↑	2	0	2	•	•
Frigidaire Gallery FGEH3047VF	76	\$1,300	↑	↓	↑	↑	↑	↑	↑	↑	↑	2	0	2	•	•
Samsung NE59M4320SS	75	\$800	↓	↓	↑	↑	↑	↑	↓	↑	↑	2	0	2	•	•
Frigidaire FFEF3054TS	73	\$720	↑	↓	↑	↑	↑	↑	↓	↑	↑	2	0	2	•	•
GE JS645SLSS	72	\$1,360	↑	↓	↑	↓	↓	↓	↑	↑	↑	2	0	2	•	•
Electrolux EI30EF45QS	71	\$2,380	↓	↓	↑	↑	↑	↑	↑	↓	↑	2	0	2	•	•
Café CES700P2MS1	70	\$2,070	↑	↓	↑	↑	↑	↓	↑	↓	↓	1	2	1	•	•
Frigidaire FFEH3054US	69	\$1,000	↑	↓	↑	↓	↓	↓	↑	↑	↑	2	0	2	•	•
Frigidaire FFEH3051VS	69	\$1,000	↑	↓	↑	↓	↓	↓	↑	↑	NA	2	0	2	•	•
GE JBS60RKSS	68	\$640	↑	↓	↑	↓	↓	↓	↑	↑	NA	1	1	2	•	•
Kenmore Elite 95223	66	\$1,605	↑	↓	↑	↑	↑	↑	↑	↑	↓	2	0	2	•	•
Kenmore 95123	66	\$1,385	↑	↓	↑	↑	↓	↓	↑	↑	↓	2	0	2	•	•
KitchenAid KFEG500ESS	63	\$1,170	↓	↓	↑	↑	↑	↓	↑	↑	↓	2	0	2	•	•
Samsung NE59T7511SS	63	\$1,000	↓	↓	↑	↑	↑	↓	↑	↑	↑	2	0	2	•	•
Whirlpool WFE775H0HZ	62	\$1,035	↑	↓	↑	↑	↓	↓	↑	↑	↓	2	0	2	•	•
GE JB645RKSS	62	\$685	↑	↓	↑	↓	↓	↓	↑	↑	↑	2	0	2	•	•
Whirlpool WFE320M0EW	61	\$465	↑	↓	↑	↑	↓	↓	↑	↑	NA	2	0	2	•	•
KitchenAid KSEB900ESS	61	\$2,515	↓	↓	↑	↑	↓	↓	↑	↑	↓	2	0	2	•	•
Whirlpool WFE975H0HV	60	\$1,260	↑	↓	↑	↓	↑	↑	↑	↑	↓	2	0	2	•	•
Whirlpool WEE745H0FS	60	\$1,800	↑	↓	↑	↓	↓	↓	↑	↑	↓	2	0	2	•	•
Frigidaire FFEF3052TS	59	\$655	↑	↓	↑	↑	↓	↓	↓	↓	NA	2	0	2	•	•
Whirlpool WEE750H0HZ	57	\$1,800	↑	↓	↑	↓	↑	↑	↑	↑	↓	2	0	2	•	•
Frigidaire FCRE3052AS	52	\$750	↑	↓	↑	↑	↓	↓	↑	↑	NA	2	0	2	•	•
Whirlpool WFE550S0HZ	52	\$900	↑	↓	↑	↑	↓	↓	↑	↑	↑	2	0	2	•	•
Whirlpool WFE525S0HZ	49	\$700	↑	↓	↑	↓	↓	↓	↑	↑	↑	2	0	2	•	•
Maytag MER6600FZ	48	\$765	↑	↓	↑	↑	↓	↓	↑	↓	↓	2	0	2	•	•
Amana AER6303MFS	48	\$475	↑	↓	↓	↑	↓	↓	↑	↑	NA	0	2	2	•	•

Brand + Model	Overall Score	Price	Survey Results		Test Results						Features					
			Predicted reliability	Owner satisfaction	Cooktop, high	Cooktop, low	Baking	Broiling	Oven capacity	Self-cleaning	High-power burners	Medium-power burners	Low-power burners	Convection mode	Slide-in	Stainless steel available
SMOOTHTOP, DOUBLE-OVEN (30-INCH)																
✓ LG LTE4815ST	82	\$2,500	↑	↓	↑↑	↑↑	↓	↑↑	↑↑	↑↑	2	0	2	•		•
Samsung NE59J7850WS	79	\$1,400	↓	↓	↑	↑	↑	↑	↑	↑	1	2	1	•		•
Maytag MET8800FZ	76	\$1,745	↑	↓	↑	↑	↑	↓	↑	↓	1	2	1	•		•
ELECTRIC INDUCTION																
✓ LG LSE4617ST	84	\$3,700	↑	↓	↑↑	↑	↑↑	↑	↑	↓	2	2	0	•		•
Samsung NE58K9560WS	80	\$2,430	↓	↓	↑↑	↑	↑	↑	↑	↓	1	3	0	•	•	•
KitchenAid KFID500ESS	73	\$2,680	↓	↓	↑↑	↑	↓	↓	↑	↓	2	2	0	•		•
GAS AND DUAL-FUEL, SINGLE-OVEN (30-INCH)																
✓ Samsung NX58H9500WS	81	\$1,980	↑↑	↑	↑	↑↑	↑	↑	↑	↑	2	2	1	•	•	•
Ⓢ Samsung NX58R5601SS	79	\$730	↑↑	↑	↑	↑↑	↑	↑	↑	↓	2	2	1	•		•
✓ LG LSD4913ST (dual-fuel)	77	\$2,400	↑	↑	↑	↑	↑	↑	↑	↓	2	2	1	•		•
Ⓢ LG LRGL5823S	74	\$1,000	↑	↑	↑	↑	↓	↓	↑	↓	2	2	1	•		•
✓ LG LSG4513ST	72	\$2,300	↑	↑	↑	↓	↑	↓	↑	↓	2	2	1	•		•
✓ GE JGB735SPSS	72	\$1,080	↑	↓	↑	↑	↓	↓	↑	↑	2	2	1	•		•
GE JGB660SEJSS	70	\$865	↑	↓	↑	↑	↓	↓	↑	↑	2	2	1			•
LG LRG3194ST	70	\$1,045	↑	↑	↓	↑	↑	↓	↑	↓	2	2	1	•		•
Frigidaire FFGF3054TS	70	\$765	↑	↓	↑	↑	↑	↓	↓	↑	2	2	1			•
GE JGBS66EEKES	70	\$810	↑	↓	↓	↑	↓	↓	↑	NA	2	2	1			•
Café CGS700M2NS5	69	\$3,300	↑	↑	↑	↑	↑	↑	↓	↓	3	2	1	•		•
GE JGSS66EELES	68	\$1,460	↑	↓	↓	↑	↓	↓	↑	NA	2	2	1			•
GE JGBS30REKSS	67	\$505	↑	↓	↓	↑	↓	↓	↑	NA	1	2	1			•
Samsung NX58R4311SS	67	\$800	↑↑	↑	↑	↓	↓	↓	↑	↓	2	2	1			•
GE JGBS60DEKWW	67	\$540	↑	↓	↓	↑	↓	↓	↑	NA	1	2	1			•
Frigidaire FFGH3054US	66	\$1,205	↑	↓	↑	↑	↓	↓	↓	↑	2	2	1			•
Frigidaire FFGH3051VS	66	\$1,095	↑	↓	↑	↑	↓	↓	↓	NA	2	2	1			•
GE JGB635REKSS	64	\$785	↑	↓	↓	↑	↓	↓	↓	↓	1	2	1			•
Frigidaire FGGH3047VF	64	\$1,900	↑	↓	↑	↑	↓	↓	↑	↑	2	2	1	•		•
Kenmore 74423	59	\$870	↑	↓	↑	↑	↓	↓	↓	NA	2	2	1			•
KitchenAid KSGG700ESS	58	\$2,070	↓	↓	↓	↑	↑	↓	↑	↓	2	2	1	•		•
Kenmore 75123	58	\$1,485	↑	↓	↑	↓	↑	↓	↑	↓	2	2	1	•		•
Frigidaire FFGF3052TS	57	\$530	↑	↓	↑	↑	↓	↓	↓	NA	2	2	1			•
KitchenAid KFGG500ESS	54	\$1,300	↓	↓	↑	↓	↑	↓	↑	↓	2	2	1	•		•
Whirlpool WEG745H0FS	52	\$1,710	↓	↓	↓	↓	↑	↓	↑	↓	2	2	1	•		•
Bosch HGI8056UC	51	\$2,070	↑	↑	↓	↓	↓	↓	↓	↓	2	1	2	•	•	•
Electrolux EI30GF45QS	51	\$2,580	↓	↓	↑	↓	↓	↓	↓	↓	2	2	1	•		•
Whirlpool WFG975H0HZ	49	\$1,260	↓	↓	↓	↓	↑	↓	↑	↓	2	2	1	•		•
Whirlpool WEG750H0HZ	49	\$2,100	↓	↓	↓	↓	↑	↓	↑	↓	2	2	1	•		•

Brand + Model	Overall Score	Price	Survey Results		Test Results						Features					
			Predicted reliability	Owner satisfaction	Cooktop, high	Cooktop, low	Baking	Broiling	Oven capacity	Self-cleaning	High-power burners	Medium-power burners	Low-power burners	Convection mode	Slide-in	Stainless steel available
GAS AND DUAL-FUEL, SINGLE-OVEN (30-INCH) <i>Continued</i>																
Whirlpool WFG550S0HZ	48	\$990	↓	↓	↓	↑	↓	↓	↑	↑	2	2	1	•	•	
Frigidaire FFGF3012TW	45	\$540	↑	↓	↓	↓	↓	↓	↓	NA	0	4	0			
Kenmore 75113	44	\$1,220	↑	↓	↓	↓	↑	↓	↑	↑	2	1	1		•	
Amana AGR6603SF	44	\$730	↓	↓	↓	↑	↑	↓	↑	↓	1	2	1			
Maytag MGR6600FZ	43	\$855	↓	↓	↓	↑	↑	↓	↑	↓	2	2	1		•	
Whirlpool WFG505M0BS	41	\$750	↓	↓	↓	↑	↑	↓	↑	NA	2	2	1		•	
Whirlpool WEG515S0FS	38	\$1,260	↓	↓	↓	↓	↑	↓	↑	↑	2	1	1		•	
Amana AGR5330BAS	38	\$510	↓	↓	↓	↓	↑	↓	↑	NA	0	3	1		•	
Thor Kitchen LRG3001U	37	\$1,600	—	—	↑	↓	↓	↓	↑	NA	1	2	2	•	•	
GAS AND DUAL-FUEL, DOUBLE-OVEN (30-INCH)																
✓ LG Signature LUTD4919SN (dual-fuel)	85	\$3,600	↑	↑	↑	↑	↑	↑	↑	↑	2	2	1	•	•	
✓ Café C2S950P2MS1 (dual-fuel)	77	\$3,240	↑	↑	↑	↑	↑	↓	↑	↑	3	2	1	•	•	
✓ GE Profile PGS960SELSS	74	\$2,880	↑	↓	↑	↑	↓	↑	↑	↓	2	2	1	•	•	
✓ GE JGBS86SPSS (dual-fuel)	73	\$1,395	↑	↓	↓	↑	↑	↑	↑	NA	2	2	1	•	•	
✓ Samsung NX58M6850SG	73	\$1,400	↑	↑	↓	↑	↓	↓	↑	↓	2	2	1	•	•	
GE JGB860SEJSS	66	\$1,660	↑	↓	↑	↑	↑	↓	↑	↓	2	2	1	•	•	
KitchenAid KFGD500ESS	60	\$1,980	↓	↓	↓	↑	↓	↓	↑	↓	1	2	2	•	•	
Whirlpool WGG745S0FS	59	\$1,440	↓	↓	↓	↑	↑	↓	↑	↑	1	2	2	•	•	
GE Profile PGB960SEJSS	51	\$1,980	↑	↓	↓	↑	↑	↓	↑	↓	2	2	1	•	•	
PRO-STYLE GAS AND DUAL-FUEL (30-INCH)																
✓ Monogram ZGP304NRSS	69	\$4,500	↓	↑	↓	↑	↓	↓	↑	↓	1	3	0	•	•	
KitchenAid KFDC500JSS (dual-fuel)	67	\$4,665	↓	↑	↑	↑	↑	↑	↑	↓	3	0	1	•	•	
Miele HR 1124 G	58	\$5,700	↓	↑	↑	↓	↓	↑	↑	↑	4	0	0	•	•	
Viking VGIC53024BSS	42	\$4,320	↓	↓	↓	↓	↓	↓	↑	↓	4	0	0	•	•	
Fisher & Paykel OR30SCG4X1	28	\$3,900	↓	↓	↑	↓	↓	↓	↓	NA	2	2	0	•	•	
PRO-STYLE GAS (36-INCH)																
Kucht KRG3618U	66	\$3,090	—	—	↑	↑	↑	↓	↓	NA	6	0	0	•	•	
Viking VGR5366BSS	59	\$6,990	↓	↓	↑	↑	↓	↓	↑	NA	6	0	0	•	•	
Jenn-Air JGRP436HL	53	\$6,200	↓	↓	↑	↑	↑	↓	↑	↓	5	1	0	•	•	
Haier HCR6250AGS	43	\$2,000	—	—	↑	↓	↓	↓	↓	NA	1	3	1	•	•	

HOW WE TEST: Overall Score combines test results with survey data for predicted reliability and owner satisfaction. Predicted reliability estimates the likelihood that newly purchased models from a given brand will develop problems or break within the first five years. Owner satisfaction reflects the proportion of CR members

who are extremely likely to recommend the range they bought. In cases where we have insufficient survey data to provide a brand-level rating, indicated by a gray dash (—), we assume the model has average reliability and satisfaction. Cooktop, high is a measure of how quickly the highest-power burner brings a large pot of water to a near-boil.

Cooktop, low indicates how steadily a low-power burner maintains low heat and whether the highest-power burner, set to low, maintains a simmer. Baking is a rating of how evenly the oven bakes cakes and cookies on multiple racks. Broiling is a measurement of how well the upper element or burner browns a full tray of hamburger patties, and how

even it is. Oven capacity is a measure of usable space in the cavity. (For double-oven ranges, the rating covers both ovens.) Self-cleaning evaluates the oven's ability to clean itself of a lab-calibrated mixture of sticky foods, including pie filling, lard, eggs, and tapioca. Price is approximate retail.





Cooktops

Choice Cooktops

OUR TOUGH TESTS REVEAL WHICH COOKTOPS BOIL FAST AND SIMMER SLOW. USE THIS GUIDE TO CHOOSE A MODEL WITH THE RIGHT MIX OF FEATURES, PERFORMANCE, AND RELIABILITY.

Installing a separate cooktop and wall oven offers a few advantages over a range. For starters, you can mount the oven higher up in wall cabinets so that you don't have to bend to pull out a large pan or a hot tray of cookies. You also gain some flexibility with your kitchen's layout. If you're adding the appliances as part of a remodel, you can install a cooktop in an island instead of against a wall. Use our buying advice and ratings to find a cooktop with the best performance, features, and price for you.

● CHOOSING THE RIGHT TYPE

To choose the right cooktop for your kitchen, take both your space and your cooking style into account.

SIZE

Most cooktops are 30 or 36 inches wide, so that's what we test. But you'll find cooktops ranging from 21 to 48 inches. Some have five or even six burners, but that doesn't mean you'll have room to use them all at once.

FUEL

Both electric and gas cooktops are capable of delivering a fine performance. But you may find it easier to judge heat by the appearance of a gas flame. And when you turn a knob from high to medium on a gas model, the pot and the food in it experience that change almost immediately.

Electric elements tend to heat faster and maintain low heat better than gas burners. Electric induction cooktops use an electromagnetic field to directly heat pans, offering quick response and control. In our tests, no other technology was faster than the fastest induction elements, but we're talking 1 to 3 minutes faster to bring a large pot of water to a near-boil.

FEATURES

A high-power cooktop element or burner will heat large pots and pans more quickly. Touch-sensitive controls on smoothtops are sleek, but some are less intuitive than old-school knobs. Manufacturers tout the high Btu of burners, but we've found that they don't always deliver faster heating.



● FEATURES THAT MATTER MOST

These are the key details to consider when shopping for a new cooktop.

HOT-SURFACE WARNING LIGHTS

They're an important safety feature because the cooktop surface can remain hot long after an element has been

turned off. Many smoothtops have at least one warning light. Ideally, each element should have a separate warning light.

EXPANDABLE ELEMENTS, A BRIDGE, AND OVAL BURNERS

On gas cooktops, oval burners accommodate

griddles and elongated pans. Most smoothtops have an expandable burner that lets you choose the size that best matches a pot's diameter. Some cooktops have an elongated bridge element that spans two burners to accommodate rectangular or odd-

shaped cookware, such as a griddle. (In some, one knob or touch control operates both.)

CONTROLS

On cooktops, the controls take up space on the surface and can limit the area that cookware can cover. Electric models with touch-sensitive controls provide a flat, easy-to-clean surface, but they can be finicky.



MONEY SAVER

Don't pay a premium for a 30-inch cooktop with a fifth burner. You'll find cooking very cramped with five pots or pans anyway. If you often need more than four burners, upgrade to a 36-inch model instead.



GOOD TO KNOW

Keep It Clean

Smoothtop cooktops are easy to clean if you follow some simple precautions. Wipe up sugary spills quickly so that they won't cause permanent damage as they cool. Wipe wet spills with a sponge, soft cloth, or paper towel. Don't use scouring sponges, which can scratch the surface. Remove heavy, burned-on residue with a glass scraper made for this purpose or a razor blade (very carefully). Polish regularly with a cooktop cleanser such as Cerama Bryte or Magic Glass Cooktop Cleaner, which worked well in our tests. Move cookware across the surface gently to avoid scratching.



● WHAT'S ON THE MARKET?

Choose from electric smoothtops, electric induction smoothtops, or gas. You'll find that each has advantages.

SMOOTHTOP

Electric radiant smoothtops are a popular pick. All of the models we tested have at least one high-power burner.

Most have expandable dual or triple elements that let you switch from a large, high-power element to a small, low-power element within it.

There's a lot of residual heat, so when reducing the heat it can take a few minutes to settle at the lower setting. Smoothtops make it

easy to clean up spills but require a special cleaner, and dropped pots and sugary spills can damage them.

INDUCTION

Electric induction cooktops use magnetic coils below the ceramic glass surface to quickly generate heat directly

in a pan, offering precise simmering and control. You'll see these models in our ratings of electric cooktops.

Magnetic cookware is needed for induction to work. If a magnet sticks strongly to the bottom of a pot, it will work with an induction cooktop. Some stainless steel pots and pans are induction-capable, and some aren't.

GAS

If you prefer cooking with gas, we get it. The flame makes it easier

to judge the heat and to quickly move from a high setting to a low one.

Response time is particularly quick, especially when compared with a smoothtop. When you adjust the knob on a gas cooktop, the level of the flame will change immediately—and you'll have a visual cue that the heat is on, and how high.

And with most gas burners, you can strike a match to light them when your power is out. Dinner by candlelight. Not so bad!

Recommended Products

We test a cooktop's speed and simmering capabilities, and you'll find dozens of electric smoothtops and induction cooktops in our ratings. Recommended cooktops are top scorers and don't get dinged for brand-reliability ratings based on our survey of thousands of members. CR Best Buys are recommended cooktops that combine impressive performance and value.

ELECTRIC INDUCTION



30-INCH INDUCTION

BOSCH 800 SERIES
NIT8069UC
\$2,049

100

Induction has the performance edge for electric cooktops. This model doesn't scrimp on power; it has four high-power elements and delivered excellent results in our high-heat cooking test. Low-heat cooking was equally impressive. It has touch controls and an element with a "keep warm" setting.
bosch-home.com



30-INCH INDUCTION

GE PROFILE
PHP9030DJBB
\$1,599

97

This induction cooktop delivers excellent performance at both high- and low-heat cooking. It has four elements, including three high-power, and a "bridge" element that's useful for rectangular pans—but only one large element that accommodates larger cookware. It has touch controls.
ge.com



36-INCH INDUCTION

KITCHENAID
KICU569XBL
\$1,890

95

Excellent all-around performance makes this one of our top-rated 36-inch induction cooktops. It has five elements, all of which are high-power, plus flexible cooking zones for different-sized cookware. The elements can be set to turn off with a countdown timer.
kitchenaid.com

GAS



30-INCH GAS

SAMSUNG
NA30N7755TS
\$1,360

92

This top pick provides superb simmering and very good high-heat performance. One of its five burners is high-power. It comes with a griddle pan and is WiFi-enabled for use with Samsung's "Smart Home" app.
samsung.com



30-INCH GAS

SAMSUNG
NA30N6555TS
\$999

91

This excellent 30-inch gas cooktop has five burners, including two high-power, and continuous grates. It has very good high-heat performance and simmering is superb. It has a stainless steel surface and a hefty pro-style look.
samsung.com



30-INCH GAS

MONOGRAM
ZGU30RSLSS
\$1,730

84

Overall, this cooktop is excellent, providing very good high-heat performance and excellent simmering. It has five burners, including two high-power, and continuous grates.
ge.com



30-INCH GAS

SAMSUNG
NA30R5310FS
\$799

80

This four-burner model excels at low-heat cooking, easily keeping tomato sauce at a simmer, but its high-heat performance is just good. It has two high-power burners, continuous grates, and a stainless steel surface.
samsung.com

ELECTRIC SMOOTHTOP



30-INCH SMOOTHTOP

BOSCH
800 SERIES NET8068SUC
 \$1,149

92

This model excelled at simmering. Fast heating was also very good. It has four elements, including one high-power, and a bridge element that is helpful for large pans.

bosch-home.com



30-INCH SMOOTHTOP

GE
JP5030SJSS
 \$1,075

92

This top performer boasts fast heating and precise simmering. It has four elements; one is high-power and one is expandable. Touch controls provide a sleek look and make cleanup easier.

ge.com



36-INCH SMOOTHTOP

CAFÉ
CEP9036N
 \$1,529

91

Superb all-around performance help send this 36-inch smoothtop to the front of the pack. It has five elements, including two that are high-power. The left-side elements can combine to use a single control for heating griddles and large pans.

cafeappliances.com



36-INCH SMOOTHTOP

LG
LCE3610SB
 \$910

91

This smoothtop cooktop excels at simmering and delivering fast heat. It has five elements, including two that are high-power, three expandable elements, and a warming element. It has touch controls.

lg.com



36-INCH GAS

SAMSUNG
NA36N7755TS
 \$1,420

92

Overall, this cooktop is excellent, providing very good high-heat performance and excellent simmering. It has five burners, including two high-power, and comes with a griddle pan and a grate adapter for a wok.

samsung.com



36-INCH GAS

THERMADOR MASTERPIECE STAR
SGSX365TS
 \$1,999

83

An excellent overall performer, this 36-inch cooktop is excellent at simmering and very good at high-heat cooking. It has five burners, three of which are high-power, and continuous grates, which make it easier to move cookware across the surface.

thermador.com

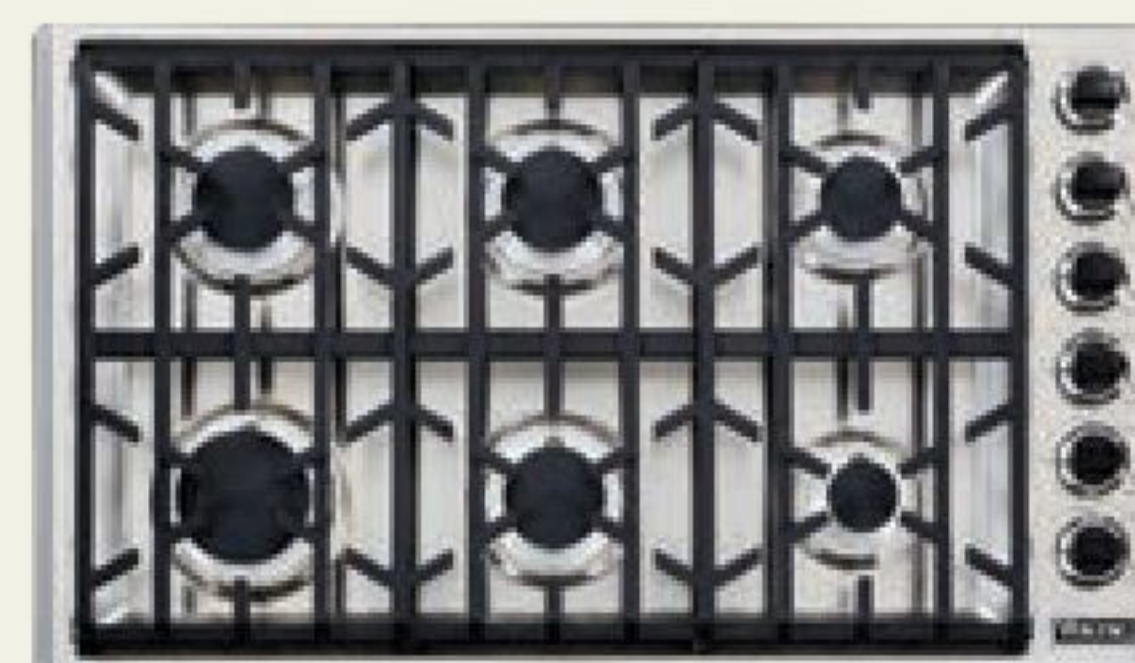

36-INCH GAS

VIKING 5 SERIES
VGSU53616BSS
 \$2,350

82

This excellent 36-inch cooktop has six burners, three of which are high-power. High-heat performance is rated Very Good and low-heat is Excellent. The burners reignite automatically, and the continuous grates mean it's easy to reposition cookware.

vikingrange.com



36-INCH GAS

GE PROFILE
PGP7036SLSS
 \$1,100

77

Excellent simmering and very good high-heat performance help this 36-inch cooktop stand out in our tests. It has five burners, two of which are high-power. It has continuous grates and a stainless steel surface.

ge.com

Brand + Model	Overall Score	Price	Survey Results		Test Results		Features				
			Predicted reliability	Owner satisfaction	High heat	Low heat	High-power elements	Medium-power elements	Low-power elements	Expandable elements	Touch controls
30-INCH ELECTRIC SMOOTHTOPS											
✓ Bosch 800 Series NET8068SUC	92	\$1,149	⬆️	⬆️	⬆️	⬆️	1	2	1		•
✓ GE JP5030SJSS	92	\$1,085	⬆️	⬇️	⬆️	⬆️	1	0	3	•	•
✓ GE Profile PP9030SJSS	92	\$1,499	⬆️	⬇️	⬆️	⬆️	2	2	1	•	•
✓ Samsung NZ30K7570RG	90	\$1,299	⬆️	⬇️	⬆️	⬆️	1	3	1	•	•
✓ KitchenAid KCED600GSS	89	\$1,665	⬆️	⬇️	⬆️	⬆️	2	0	2	•	
✓ KitchenAid KCES550HBL	87	\$1,080	⬆️	⬇️	⬆️	⬆️	2	1	2	•	
✓ Frigidaire Gallery FGEC3068UB	87	\$850	⬆️	⬇️	⬆️	⬆️	1	2	2	•	
💰 GE JP3030SJSS	85	\$675	⬆️	⬇️	⬆️	⬆️	2	0	2		
Maytag MEC8830HB	79	\$800	⬆️	⬇️	⬆️	⬆️	1	2	1	•	
Frigidaire FFEC3025UB	76	\$699	⬆️	⬇️	⬆️	⬆️	2	0	2	•	
Samsung NZ30R5330RK	73	\$700	⬆️	⬇️	⬆️	⬆️	1	3	0	•	
GE JP3530SJSS	72	\$915	⬆️	⬇️	⬆️	⬆️	2	1	1	•	
Whirlpool WCE77US0HB	68	\$680	⬆️	⬇️	⬆️	⬇️	2	0	2	•	
Amana AEC6540KFB	65	\$490	⬆️	⬇️	⬆️	⬇️	1	1	2		
Whirlpool WCE55US0HB	64	\$585	⬆️	⬇️	⬆️	⬇️	1	1	2	•	
36-INCH ELECTRIC SMOOTHTOPS											
✓ Café CEP90361NBB	91	\$1,529	⬆️	⬇️	⬆️	⬆️	2	2	1	•	•
✓ LG LCE3610SB	91	\$910	⬆️	⬇️	⬆️	⬆️	2	1	1	•	•
✓ Samsung NZ36K7570RG	90	\$1,399	⬆️	⬇️	⬆️	⬆️	2	2	1	•	•
✓ KitchenAid KCED606GBL	89	\$1,620	⬆️	⬇️	⬆️	⬆️	2	1	2	•	
✓ Bosch Benchmark Series NETP668SUC	87	\$1,400	⬆️	⬆️	⬆️	⬆️	1	3	1	•	•
✓ GE JP5036DJBB	84	\$1,060	⬆️	⬇️	⬆️	⬆️	2	1	2	•	•
Whirlpool WCE55US6HB	79	\$640	⬆️	⬇️	⬆️	⬆️	2	0	2	•	
GE Profile PP7036SJSS	64	\$1,399	⬆️	⬇️	⬆️	⬇️	2	2	1	•	
30-INCH ELECTRIC INDUCTION COOKTOPS											
✓ Bosch 800 series NIT8069UC	100	\$2,049	⬆️	⬆️	⬆️	⬆️	4	0	0		•
✓ GE Profile PHP9030DJBB	97	\$1,599	⬆️	⬇️	⬆️	⬆️	3	1	0		•
✓ Monogram ZHU30RSJSS	97	\$2,730	⬆️	⬇️	⬆️	⬆️	3	1	0		•
✓ Samsung NZ30K7880UG	94	\$1,749	⬆️	⬇️	⬆️	⬆️	3	1	0	•	•
✓ Frigidaire FFIC3026TB	92	\$1,395	⬆️	⬇️	⬆️	⬆️	2	2	0		•
✓ Whirlpool GCI3061XB	92	\$1,355	⬆️	⬇️	⬆️	⬆️	2	0	2		•
Viking Virtuoso 6 Series MVIC6304BBG	80	\$2,810	⬇️	⬇️	⬆️	⬆️	3	1	0		•
36-INCH ELECTRIC INDUCTION COOKTOPS											
✓ Bosch Benchmark Series NITP669SUC	99	\$2,999	⬆️	⬆️	⬆️	⬆️	5	0	0		•
✓ KitchenAid KICU569XBL	95	\$1,890	⬆️	⬇️	⬆️	⬆️	5	0	0		•
✓ Samsung NZ36K7880UG	94	\$2,135	⬆️	⬇️	⬆️	⬆️	4	1	0	•	•
✓ Frigidaire FPIC3677RF	93	\$1,865	⬆️	⬇️	⬆️	⬆️	4	1	0		
✓ Frigidaire FFIC3626TB	92	\$1,590	⬆️	⬇️	⬆️	⬆️	3	2	0		•
Jenn-Air JIC4536XS	84	\$2,300	⬇️	⬇️	⬆️	⬆️	5	0	0	•	•

Brand + Model	Overall Score	Price	Survey Results		Test Results		Features				
			Predicted reliability	Owner satisfaction	High heat	Low heat	High-power burners	Medium-power burners	Low-power burners	Stainless steel	Continuous grates
30-INCH GAS COOKTOPS											
Samsung NA30N7755TS	92	\$1,360					2	2	1	•	•
Samsung NA30N6555TS	91	\$999					2	2	1	•	•
Monogram ZGU30RSLSS	84	\$1,730					2	3	0	•	•
Samsung NA30R5310FS	80	\$799					2	1	1	•	•
GE Profile PGP7030SLSS	77	\$1,299					2	2	1	•	•
Café CGP70302NS1	76	\$1,229					2	2	1	•	•
Bosch 800 Series NGM8056UC	76	\$1,150					1	2	2	•	•
GE JGP5030SLSS	72	\$970					2	2	1	•	•
Frigidaire FFGC3026SS	71	\$500					2	1	1	•	•
GE JGP3530SLSS	66	\$825					2	1	1	•	•
KitchenAid KCGS350ESS	63	\$1,200					1	3	1	•	•
Frigidaire Gallery FGGC3047QS	62	\$1,079					2	2	1	•	•
Electrolux EW30GC60PS	61	\$1,300					2	2	1	•	•
KitchenAid KCGS950ESS	55	\$1,440					1	3	1	•	•
KitchenAid KCGD500GSS	41	\$1,800					2	1	1	•	•
Maytag MGC7430DS	41	\$735					2	1	1	•	•

36-INCH GAS COOKTOPS											
Samsung NA36N7755TS	92	\$1,420					2	2	1	•	•
Thermador Masterpiece Star SGSX365TS	83	\$1,999					3	2	0	•	•
Viking 5 Series VGSU53616BSS	82	\$2,350					3	2	1	•	•
GE Profile PGP7036SLSS	77	\$1,100					2	2	1	•	•
Café CGP70362NS1	76	\$1,329					2	2	1	•	•
GE Profile PGP9036SLSS	74	\$1,499					2	2	1	•	•
Frigidaire Gallery FGGC3645QS	71	\$1,050					2	2	1	•	•
Maytag MGC9536DS	70	\$930					2	2	1	•	•
Frigidaire Professional FPGC3677RS	63	\$1,200					2	2	1	•	•
Jenn-Air JGC3536GS	57	\$1,800					4	0	1	•	•
Miele KM 3474 G	50	\$2,099					3	2	0	•	•
KitchenAid KCGS556ESS	48	\$1,350					1	2	2	•	•
LG LCG3611ST	46	\$1,200					2	2	1	•	•

> All-Access and Digital members can find the latest, complete ratings and buying advice at [CR.org/cooktops](https://www.crisp.com/cooktops).

HOW WE TEST: Overall Score combines test results with survey data for predicted reliability and owner satisfaction. Predicted reliability estimates the likelihood that newly purchased models from a given brand will develop problems or break within the first five

years. Owner satisfaction reflects the proportion of CR members who are extremely likely to recommend the cooktop they bought. In cases where we have insufficient survey data to provide a brand-level rating, indicated by a gray dash (-), we give the model

weighted category average reliability and satisfaction scores. To test High heat, we time how long the highest-power burner takes to bring a large pot of water to a near-boil. For Low heat, we note how well the lowest-power burner keeps a low temperature, as for

melting chocolate, and how well the highest-power burner, set on low, holds tomato sauce below a boil. Price is approximate retail.





Exceptional Ovens

WHETHER PAIRED WITH A COOKTOP OR A RANGE, A WALL OVEN (OR TWO) CAN ADD FLEXIBILITY, CONVENIENCE, AND CROWD-FRIENDLY COOKING CAPACITY. USE THESE PRO TIPS TO DECIDE WHICH FEATURES MAKE SENSE FOR YOU.

Unlike a range, a wall oven can go wherever you want it: at waist or eye level so that you won't have to bend to pull out heavy pans, or even under a counter. And now lower prices have made wall-oven and cooktop pairs more affordable, though most combos will still cost more than a range. Use our ratings and reliability data as a guide as you shop. And remember that you don't have to choose the same brand for your oven and cooktop.

● CHOOSING THE RIGHT TYPE

Use these basics to help narrow down your options.

SIZE

Wall ovens come in a range of widths: 24, 27, 30, and 36 inches. Consumer Reports tests models 30 inches wide, the most popular size. You'll also find single- and double-oven styles. If you're replacing a wall oven, it's crucial that you measure the space and the cabinet cutout.

FUEL

A majority of wall ovens are electric; they usually have a larger capacity than

similar gas models and don't require a gas connection. But remember that electric wall ovens need their own electrical circuit. And no matter how your new wall oven is fueled, be sure to have it professionally installed.

CAPACITY

There was a time when choosing a wall oven over a range meant you had to settle for a small oven without a self-cleaning feature. No longer. Manufacturers are finding ways to increase capacity. Of the single wall ovens we tested, scores

for usable capacity (which differ from the figure supplied by the manufacturer) ranged from good to excellent. The smallest in our tests was just over 2 cubic feet, and the largest was more than 3 cubic feet.



MONEY SAVER

If you rarely cook for a crowd—on Thanksgiving, say—you may not need two ovens. Stick with a single model and enlist your toaster oven or microwave for side dishes when necessary.

● FEATURES THAT MATTER MOST

These functions may add convenience.

CONTROL LOCKOUT

This lets you disable the oven controls, preventing accidental operation—a good idea for households with kids.

COOK TIME/DELAY

It lets you select times for the oven to start and stop cooking. But there are few foods you'd want to put in a cold oven and let sit for delayed start.

SIDE-SWING AND FRENCH DOORS

The first is a single door with hinges on

one side. French-door models have two doors that separate in the middle and open outward. Both types prevent you from having to reach over an open door to retrieve hot food.

CONVECTION

Many ovens have one or more convection fans that circulate hot air, which can reduce cooking time.

VARIABLE BROIL

This offers adjustable settings for broiled foods, instead of only "on" (usually 500° F) and "off."

Recommended Products

Recommended wall ovens are top-scoring models that have at least good reliability ratings. CR Best Buys are recommended wall ovens that combine impressive performance and value, and at least good reliability. Ratings for double ovens are based on our tests of corresponding single-oven models.



SINGLE ELECTRIC WALL OVEN

**KITCHENAID
KOSE500ESS**
\$2,250

85

Superb broiling, impressive baking, and a large oven help this 30-inch electric wall oven stand out. It has a numeric keypad, a temperature probe, and five or more rack positions. But self-cleaning rates just Good. kitchenaid.com



SINGLE ELECTRIC WALL OVEN

**MAYTAG
MEW9530FZS**
\$1,730

83

This oven rates Excellent overall, with an exceptionally roomy capacity and Very Good ratings for baking and broiling. But self-cleaning rates just Good. It has a convection mode and touchpad controls. maytag.com



DOUBLE ELECTRIC WALL OVEN

**KITCHENAID
KODE500ESS**
\$2,200

85

This very spacious model excelled in our broiling tests and rates Very Good at baking. The self-cleaning capability is just so-so. Features include a convection mode, a temperature probe, and large oven windows. kitchenaid.com

Brand + Model	Overall Score	Price	Survey Results		Test Results				Features			
			Predicted reliability	Owner satisfaction	Baking	Broiling	Oven capacity	Self-cleaning	Width (in.)	Covered element	Convection mode	Temperature probe
SINGLE ELECTRIC WALL OVENS												
KitchenAid KOSE500ESS	85	\$2,250							30	<input type="checkbox"/>	<input type="checkbox"/>	<input type="checkbox"/>
Maytag MEW9530FZ	83	\$1,730							30	<input type="checkbox"/>	<input type="checkbox"/>	<input type="checkbox"/>
Samsung NV51K7770SG	81	\$2,790							30	<input type="checkbox"/>	<input type="checkbox"/>	<input type="checkbox"/>
Café CTS70DM2NS5	80	\$2,800							30	<input type="checkbox"/>	<input type="checkbox"/>	<input type="checkbox"/>
LG LWS3063ST	78	\$1,620							30	<input type="checkbox"/>	<input type="checkbox"/>	<input type="checkbox"/>
Electrolux EW30EW55PS	78	\$2,290							30	<input type="checkbox"/>	<input type="checkbox"/>	<input type="checkbox"/>
GE JTS5000SNSS	78	\$1,950							30	<input type="checkbox"/>	<input type="checkbox"/>	<input type="checkbox"/>
Frigidaire Gallery FGEW3066UF	77	\$1,300							30	<input type="checkbox"/>	<input type="checkbox"/>	<input type="checkbox"/>
Whirlpool WOS72EC0HS	77	\$1,910							30	<input type="checkbox"/>	<input type="checkbox"/>	<input type="checkbox"/>
Jenn-Air JJW3430DS	76	\$3,900							30	<input type="checkbox"/>	<input type="checkbox"/>	<input type="checkbox"/>
KitchenAid KOST100ESS	76	\$2,200							30	<input type="checkbox"/>	<input type="checkbox"/>	<input type="checkbox"/>
Electrolux EI30EW38TS	76	\$2,100							30	<input type="checkbox"/>	<input type="checkbox"/>	<input type="checkbox"/>
KitchenAid KOSE900HSS	74	\$2,880							30	<input type="checkbox"/>	<input type="checkbox"/>	<input type="checkbox"/>
Bosch HBL8451UC	73	\$2,500							30	<input type="checkbox"/>	<input type="checkbox"/>	<input type="checkbox"/>
Whirlpool WOS51EC0HS	73	\$1,440							30	<input type="checkbox"/>	<input type="checkbox"/>	<input type="checkbox"/>
Thermador Masterpiece ME301WS	69	\$3,900							30	<input type="checkbox"/>	<input type="checkbox"/>	<input type="checkbox"/>
Bosch HBLP451RUC	69	\$3,200							30	<input type="checkbox"/>	<input type="checkbox"/>	<input type="checkbox"/>
Miele H 6281 BP	65	\$3,000							30	<input type="checkbox"/>	<input type="checkbox"/>	<input type="checkbox"/>
Whirlpool WOS31ES0JS	65	\$1,300							30	<input type="checkbox"/>	<input type="checkbox"/>	<input type="checkbox"/>
Bosch HBL5351UC	64	\$1,765							30	<input type="checkbox"/>	<input type="checkbox"/>	<input type="checkbox"/>
Frigidaire Professional FPEW3077RF	59	\$1,850							30	<input type="checkbox"/>	<input type="checkbox"/>	<input type="checkbox"/>
Amana AWO6313SFS	52	\$1,115							30	<input type="checkbox"/>	<input type="checkbox"/>	<input type="checkbox"/>
GE Profile PT9200SLSS	50	\$2,800							30	<input type="checkbox"/>	<input type="checkbox"/>	<input type="checkbox"/>
Frigidaire FFEW3026TD	50	\$1,045							30	<input type="checkbox"/>	<input type="checkbox"/>	<input type="checkbox"/>
DOUBLE ELECTRIC WALL OVENS												
KitchenAid KODE500ESS	85	\$3,600							30	<input type="checkbox"/>	<input type="checkbox"/>	<input type="checkbox"/>
Samsung NV51K7770DG	81	\$3,780							30	<input type="checkbox"/>	<input type="checkbox"/>	<input type="checkbox"/>
Café CTD70DM2NS5	80	\$3,800							30	<input type="checkbox"/>	<input type="checkbox"/>	<input type="checkbox"/>
LG LWD3063ST	78	\$1,620							30	<input type="checkbox"/>	<input type="checkbox"/>	<input type="checkbox"/>
Frigidaire Gallery FGET3066UF	77	\$2,600							30	<input type="checkbox"/>	<input type="checkbox"/>	<input type="checkbox"/>
Jenn-Air JJW3830DS	76	\$5,500							30	<input type="checkbox"/>	<input type="checkbox"/>	<input type="checkbox"/>

HOW WE TEST: Overall Score combines test results with survey data for predicted reliability and owner satisfaction. Predicted reliability estimates the likelihood that newly purchased models from a given brand

will develop problems or break within the first five years. Owner satisfaction reflects the proportion of CR members who are extremely likely to recommend the oven they bought. Baking reflects whether cakes and cookies baked on two

racks were evenly browned. Broiling is based on even browning of a pan of burgers and high-heat searing ability. Oven capacity is our measurement of usable space. Self-cleaning is a gauge of the self-cleaning cycle's

effectiveness at removing a baked-on mixture of eggs, lard, cherry pie filling, cheese, tomato purée, and tapioca. (All scores for double wall ovens are based on results from the upper oven.) Price is approximate retail.





Multitasking Microwaves

MICROWAVE OVENS ARE KNOWN FOR THEIR SPEEDY HEATING. BUT TODAY'S TOP MODELS ALSO PROMISE A RANGE OF FUNCTIONS, FROM CONVECTION COOKING TO GRILLING. HERE'S HOW TO FIND THE RIGHT MICROWAVE FOR YOUR NEEDS.

Whether you love to cook or live on frozen pizza, your microwave has probably become a kitchen essential. Defrosting and reheating are common uses, but some of our tested microwaves don't do either very well. Others can handle a wide range of functions with ease. In fact, our tests of midsized and large countertop and over-the-range models revealed big differences in overall performance. See the results in our ratings, starting on page 66.

● MAKING THE RIGHT CHOICE

Before you shop, decide whether an under-the-counter, over-the-range, or countertop model will suit your needs best.

TYPE

Countertop models are the most widely sold. They come in small, medium, and large versions and can sit just about anywhere you have a nearby outlet. Over-the-range models are just that: They're installed over a range and include venting capability (though our tests have shown that it's rarely very effective). The built-in category includes models designed to be surrounded by cabinetry or recessed into a wall. Microwave drawers fall in this group and can be placed under a countertop or below a wall oven.

SPACE AND LOCATION

You might not want to sacrifice cabinet space for a built-in model. On the other hand, countertop models eat up counter space. For example, the top-rated midsize model is 22 inches wide and 18 inches deep. The best large microwave we tested is 22 inches wide and 19 inches deep.

BUDGET

Countertop microwaves usually cost less than the other types, and midsize models start around \$80. Over-the-range microwaves, or OTRs, can be had for less than \$200, but most we tested cost \$400 and up. Models designed to be built into cabinetry or a wall begin at \$400, but kits are available for certain countertop models that give you a built-in look for less.

● FEATURES THAT MATTER MOST

More options may sound appealing, but think about what you'll really use before you pay more for them. Here's what to consider.

TURNTABLES AND TRAYS

Most microwaves have a turntable that rotates food for uniform heating. But some have a

rectangular tray that slides from side to side, which might work better for large casseroles or platters.

QUICK KEYS

A 1-minute or 30-second key requires just a tap to extend the preset cooking time, defaulting to the high-power cooking level. The key

also allows quick adjustments to your previous settings. Pushing the button more than once multiplies the time extension.

RACKS

These let you speed things up by cooking multiple dishes simultaneously. They may also be used to

improve convection cooking by allowing heat beneath the cooking dish. But you could have trouble fitting even a coffee mug in certain models unless you remove the rack, so check when shopping.

SHORTCUT KEYS

They take the guesswork out of cooking food

that's often microwaved, such as popcorn and frozen vegetables.

CONVECTION COOKING, GRILLING, AND BROWNING

These features offer the appeal of a second oven in your kitchen. But none of the models we tested provided the consistent results





● WHAT'S ON THE MARKET?

Depending on your kitchen, you can choose from countertop, over-the-range, and built-in microwaves (including drawer-style). The size of the unit doesn't always translate to usable cooking space. Our research has found that usable capacity for tested microwaves is about 50 to 60 percent of what manufacturers claim. More watts usually means more cooking power, but differences of 100 watts or so don't matter much. Prices, usable capacity, and watts are based on our tested models.

COUNTERTOP MICROWAVES

This basic style offers appealing pricing and easy installation. Just plug it into an ordinary outlet—one dedicated to the microwave, or it might trip the circuit breaker. These units eat up counter space, so note the microwave's dimensions, choosing the largest capacity for the available space. Also check the instructions for the recommended clearance around the appliance.

PRICE \$50 to \$150 for small (compact), \$70 to \$500 for midsized, and \$70 to \$620 for large.

USABLE CAPACITY

Most tested models in this category have usable capacity that's about 50 to 60 percent of what manufacturers claim. Usable capacity ranges are 0.4 to 0.5 cubic feet for small (compact),

0.5 to 0.8 cubic feet for midsized, and 0.7 to 1.5 cubic feet for large.

WATTS 700 to 950 for small (compact), 800 to 1,200 for midsized, and 950 to 1,300 for large.

OVER-THE-RANGE MICROWAVES

Known as OTRs, these models free up counter space and typically include venting capability, but they usually don't vent as well as a range hood. Plan on installation by a pro.

PRICE \$130 to \$1,200.

USABLE CAPACITY Most tested models have a usable capacity that's about 50 to 60 percent of what manufacturers claim. Usable capacity is 0.6 to 1.5 cubic feet.

WATTS 850 to 1,100.

BUILT-IN MICROWAVES

This category includes models designed to be surrounded by cabinetry or built into a wall. Microwave drawers, for example, can be installed

under a countertop or beneath a wall oven. Some countertop models can be built in with a kit.

The information below is for models designed only to be built in, not for countertop models with optional built-in kits.

PRICE \$380 to \$1,440.

USABLE CAPACITY We haven't tested enough built-ins to determine the percentage of usable capacity compared with manufacturer claims. Usable capacity ranges from 0.9 to 1.1 cubic feet.

WATTS 950 to 1,100.

that you'd get from a regular oven or a grill.

A CHILD LOCK

If there are children in the household, a lockout function helps prevent them from operating the microwave.



MONEY SAVER

The most important microwave features are a sensor, a turntable, and a defrost function. There's no need to spend more for

multiple shortcut keys or grilling capability. But convection mode can be worth a little extra, because it gives you a second oven for baking or roasting.

Brand + Model	Overall Score	Price	Survey Results		Test Results						Specs			Features			
			Predicted reliability	Owner satisfaction	Heating evenness	Defrosting evenness	Speed of heating	Microwaving noise	Ease of use	Venting (airflow)	Claimed capacity (cu. ft.)	Usable capacity (cu. ft.)	Watts	Detailed prompts	Convection mode	Sensor	Stainless/SS-look option
OVER-THE-RANGE MICROWAVES																	
✓ Whirlpool WMH53521H	87	\$470	⬆️	⬇️	⬆️	⬆️	⬆️	⬆️	⬆️	⬆️	⬆️	2.1	0.9	1000	●	●	●
✓ Whirlpool WMH75021HZ	86	\$470	⬆️	⬇️	⬆️	⬆️	⬆️	⬆️	⬆️	⬆️	⬆️	2.1	0.9	1100	●	●	●
✓ GE Profile PVM9005SJSS	84	\$500	⬆️	⬇️	⬆️	⬆️	⬆️	⬆️	⬆️	⬆️	⬆️	2.1	1.0	1050	●	●	●
✓ KitchenAid KMHS120ESS	84	\$585	⬆️	⬇️	⬆️	⬆️	⬆️	⬆️	⬆️	⬆️	⬆️	2.0	1.0	1000	●	●	●
✓ Café CVM721M2NS5	82	\$855	⬆️	⬇️	⬆️	⬆️	⬆️	⬆️	⬆️	⬆️	⬆️	2.1	1.0	1050	●	●	●
✓ LG LMV2031ST	81	\$350	⬆️	⬆️	⬆️	⬆️	⬆️	⬆️	⬆️	⬆️	⬆️	2.0	0.9	1000	●	●	●
✓ LG LMH2235ST	81	\$450	⬆️	⬆️	⬆️	⬆️	⬆️	⬆️	⬆️	⬆️	⬆️	2.2	0.9	1000	●	●	●
✓ Frigidaire Professional FPBM3077RF	80	\$595	⬆️	⬇️	⬆️	⬆️	⬆️	⬆️	⬆️	⬆️	⬆️	1.8	0.9	1050	●	●	●
✓ Kenmore 83337	79	\$405	⬆️	⬇️	⬆️	⬆️	⬆️	⬆️	⬆️	⬆️	⬆️	1.7	0.8	1000	●	●	●
✓ Frigidaire Gallery FGMV17WNVF	77	\$380	⬆️	⬇️	⬆️	⬆️	⬆️	⬆️	⬆️	⬆️	⬆️	1.7	0.8	1000	●	●	●
✓ GE JVM3160RFSS	77	\$250	⬆️	⬇️	⬆️	⬆️	⬆️	⬆️	⬆️	⬆️	⬆️	1.6	0.8	1000	●	●	●
✓ Kenmore 87583	76	\$500	⬆️	⬇️	⬆️	⬆️	⬆️	⬆️	⬆️	⬆️	⬆️	2.2	0.9	1000	●	●	●
✓ Whirlpool WML55011HS	75	\$405	⬆️	⬇️	⬆️	⬆️	⬆️	⬆️	⬆️	⬆️	⬆️	1.1	0.6	1000	●	●	●

Recommended Products

Most models do a respectable job of basic microwaving tasks, such as defrosting meats, reheating leftovers, and making popcorn. You'll probably pay more for an oven with a larger capacity, a stainless steel finish, lots of presets, and functions such as convection and speed cooking.

OVER-THE-RANGE



WHIRLPOOL WMH53521H
\$470

86

Our top-rated model earns an Excellent rating for heating evenness, defrosting, and ease of use, and it's very quiet. It fits a 9x15-inch baking dish, and the turntable can be turned off. Predicted reliability has a rating of Excellent, and owner satisfaction rates Good. whirlpool.com

MIDSIZED COUNTERTOP



PANASONIC NN-SN686S
\$310

76

Very good overall, this model offers superb heating evenness, heating speed, and defrosting. But its results in our noise test were just mediocre. It has 0.7 cubic feet of usable capacity, and it provides touchpad controls and a sensor. panasonic.com

LARGE COUNTERTOP



PANASONIC NN-SE785S
\$330

87

The top-rated Panasonic rates Excellent at evenly heating food and Very Good at defrosting. It's fast at heating water and very quiet when set on high. It's easy to use and has a sensor, which measures the steam that food emits and shuts off the microwave when cooking is done. panasonic.com

Brand + Model	Overall Score	Price	Survey Results		Test Results						Specs			Features				
			Predicted reliability	Owner satisfaction	Heating evenness	Defrosting evenness	Speed of heating	Microwaving noise	Ease of use	Venting (airflow)	Claimed capacity (cu. ft.)	Usable capacity (cu. ft.)	Watts	Detailed prompts	Convection mode	Sensor	Stainless/SS-lock option	
OVER-THE-RANGE MICROWAVES <i>Continued</i>																		
Frigidaire Gallery FGBM19WNVD	75	\$435	↑	↓	↓	↑	↑	↑	↑	↑	↓	1.9	0.8	1000	•		•	•
GE JVM6175DKWW	74	\$320	↑	↓	↑	↑	↑	↑	↑	↑	↓	1.7	0.7	1000	•		•	•
Frigidaire Gallery FGMV176NTD	74	\$350	↑	↓	↓	↑	↓	↑	↑	↑	↑	1.7	0.8	1000	•		•	•
Black+Decker EM044KIN-P	73	\$200	—	—	↑	↑	↑	↑	↑	↑	↓	1.6	0.7	1000				•
Frigidaire FFMV1846VS	73	\$300	↑	↓	↓	↑	↑	↑	↑	↑	↓	1.8	0.8	1000				•
Frigidaire FFMV1645TD	73	\$320	↑	↓	↑	↑	↓	↑	↑	↑	↓	1.6	0.8	1000				•
Frigidaire FFMV1745T	72	\$280	↑	↓	↓	↑	↑	↑	↑	↑	↑	1.7	0.8	1000				•
Bosch 500 Series HMV5053U	71	\$500	↓	↓	↑	↑	↑	↑	↑	↑	↓	2.1	0.9	1100			•	•
KitchenAid KMHC319ESS	71	\$650	↑	↓	↑	↓	↓	↑	↑	↓	↓	1.9	1.0	1000	•	•	•	•
Whirlpool WMH78019HZ	71	\$570	↑	↓	↑	↓	↓	↑	↑	↓	↓	1.9	0.9	1100	•	•	•	•
LG LMV1831ST	69	\$250	↑	↑	↑	↑	↓	↑	↑	↓	↓	1.8	0.8	1000			•	•
KitchenAid KMLS311HSS	68	\$720	↑	↓	↓	↑	↓	↑	↑	↑	↑	1.1	0.6	1000	•		•	•
Café CVM517P2MS1	68	\$800	↑	↓	↓	↑	↓	↑	↑	↑	↑	1.7	0.8	950	•	•	•	•
Samsung ME20H705MSS	68	\$350	↓	↓	↑	↑	↑	↑	↑	↓	↓	2.0	1.0	1000	•		•	•
Bosch HMV8053U	67	\$675	↓	↓	↑	↑	↑	↑	↑	↓	↓	1.8	0.9	1000		•	•	•
Maytag MMV5220FZ	66	\$420	↓	↓	↓	↓	↓	↑	↑	↓	↓	2.1	0.8	1000	•		•	•
Kenmore 83533	66	\$280	↑	↓	↑	↑	↓	↑	↑	↑	↑	1.8	0.9	1000			•	•
GE Profile Advantium PSA9120SFSS	66	\$1,170	↑	↓	↓	↑	↓	↑	↑	↓	↓	1.7	0.8	925	•	•	•	•
Whirlpool UMV1160CS	65	\$180	↑	↓	↓	↑	↑	↑	↑	↓	↓	1.6	0.8	1000				•
GE Profile PVM9179SKSS	65	\$550	↑	↓	↓	↓	↓	↑	↑	↑	↑	1.7	0.8	950	•	•	•	•
Dacor Discovery PCOR30S	65	\$900	↓	↓	↑	↑	↓	↑	↑	↓	↓	1.1	0.7	850	•	•	•	•
Electrolux IQ-Touch EI30BM60MS	65	\$695	↓	↓	↑	↑	↑	↑	↑	↓	↓	1.8	0.9	1050	•	•	•	•
GE Adora DVM7195SKSS (Home Depot Exclusive)	65	\$300	↑	↓	↓	↓	↓	↑	↑	↑	↑	1.9	0.9	1000	•		•	•
Sharp SMO1652DS	64	\$280	↑	↑	↓	↑	↓	↑	↑	↑	↑	1.6	1.0	1000			•	•
Maytag MMV5227JZ	64	\$450	↓	↓	↑	↓	↓	↑	↑	↓	↓	1.9	0.8	950	•		•	•
LG LSMC3089BD	64	\$720	↑	↑	↓	↓	↓	↓	↑	↓	↓	1.7	0.8	950	•	•	•	•
Samsung ME17R7021ES	64	\$290	↓	↓	↑	↑	↓	↑	↑	↑	↑	1.7	0.7	1000				•
Samsung ME21R7051SS	62	\$300	↓	↓	↓	↑	↓	↑	↑	↑	↑	2.1	0.9	1000			•	•
Samsung ME21F707MJT	62	\$370	↓	↓	↓	↑	↑	↓	↑	↑	↑	2.1	0.9	1000	•		•	•
LG LMVH1711[ST]	60	\$540	↑	↑	↓	↑	↓	↓	↑	↓	↓	1.7	0.8	950	•		•	•
Samsung ME21M706BAS	60	\$350	↓	↓	↑	↑	↓	↑	↑	↑	↑	2.1	0.9	1000	•		•	•
Maytag MMV1175JZ	59	\$350	↓	↓	↓	↑	↓	↑	↑	↓	↓	1.9	0.9	1000				•
Café CVM9215SLSS	59	\$715	↑	↓	↓	↓	↓	↑	↑	↑	↑	2.1	0.9	1000	•		•	•
Samsung ME19R7041FS	58	\$350	↓	↓	↓	↑	↓	↑	↑	↑	↑	1.9	0.9	1000			•	•
Samsung ME18H704SFS	57	\$240	↓	↓	↓	↑	↑	↑	↑	↓	↓	1.8	0.9	1000			•	•

Brand + Model	Overall Score	Price	Survey Results		Test Results					Specs			Features				
			Predicted reliability	Owner satisfaction	Heating evenness	Defrosting evenness	Speed of heating	Microwaving noise	Ease of use	Claimed capacity (cu. ft.)	Usable capacity (cu. ft.)	Watts	Detailed prompts	Convection mode	Sensor	Stainless/SS-look option	
MIDSIZED COUNTERTOP MICROWAVES																	
✓ General GEW1000E	77	\$310	—	—	⬆️	NA	⬆️	⬆️	⬆️	⬆️	1.0	0.8	1000				•
✓ Panasonic NN-GN68KS with FlashXpress, 3-in-1	77	\$300	⬆️	⬆️	⬆️	⬆️	⬆️	⬆️	⬆️	⬆️	1.1	0.6	1000				•
✓ Panasonic NN-SN686S	76	\$175	⬆️	⬆️	⬆️	⬆️	⬆️	⬆️	⬆️	⬆️	1.2	0.7	1200				•
Farberware Black FMO12AHTBSG	74	\$110	⬆️	⬆️	⬆️	⬆️	⬆️	⬆️	⬆️	⬆️	1.2	0.6	1100				•
Breville Smooth Wave BMO850BSS1BUC1	73	\$350	⬆️	⬆️	⬆️	⬆️	⬆️	⬆️	⬆️	⬆️	1.2	0.7	1250	•			•
Breville Quick Touch BMO734XL	72	\$250	⬆️	⬆️	⬆️	⬆️	⬆️	⬆️	⬆️	⬆️	1.2	0.7	1100	•			•
Oster OGCM11S2-10	72	\$145	⬆️	⬆️	⬆️	⬆️	⬆️	⬆️	⬆️	⬆️	1.1	0.7	1000				•
Summit SCM1000SS	69	\$320	—	—	⬆️	NA	⬆️	⬆️	⬆️	⬆️	1.0	0.8	1000				•
Magic Chef MCM1110ST	69	\$80	⬆️	⬆️	⬆️	⬆️	⬆️	⬆️	⬆️	⬆️	1.1	0.6	1000				•
Samsung MG11H2020CT	68	\$180	⬆️	⬆️	⬆️	⬆️	⬆️	⬆️	⬆️	⬆️	1.1	0.7	1000				•
Cuisinart CMW-200	67	\$250	⬆️	⬆️	⬆️	⬆️	⬆️	⬆️	⬆️	⬆️	1.2	0.7	1000		•		•
Samsung MC12J8035CT	67	\$400	⬆️	⬆️	⬆️	⬆️	⬆️	⬆️	⬆️	⬆️	1.2	0.8	900		•		•
Samsung MC11K7035CG	65	\$295	⬆️	⬆️	⬆️	⬆️	⬆️	⬆️	⬆️	⬆️	1.1	0.6	1000		•		•
Magic Chef MCD1310ST	64	\$110	⬆️	⬆️	⬆️	⬆️	⬆️	⬆️	⬆️	⬆️	1.3	0.8	1000				•
Power XL Microwave Air Fryer Plus 00752356830953	63	\$220	—	—	⬆️	⬆️	⬆️	⬆️	⬆️	⬆️	1.0	0.6	1000				•
GE JES1145SHSS	63	\$115	⬆️	⬆️	⬆️	⬆️	⬆️	⬆️	⬆️	⬆️	1.1	0.6	950				•
Panasonic Prestige NN-SD372S	62	\$140	⬆️	⬆️	⬆️	⬆️	⬆️	⬆️	⬆️	⬆️	0.9	0.5	950				•
Magic Chef HMM1110B	61	\$70	⬆️	⬆️	⬆️	⬆️	⬆️	⬆️	⬆️	⬆️	1.1	0.6	1000				•
Toshiba EM131A5C-BS	60	\$120	⬆️	⬆️	⬆️	⬆️	⬆️	⬆️	⬆️	⬆️	1.2	0.7	1100				•
Sharp SMC0912BS	60	\$70	⬆️	⬆️	⬆️	⬆️	⬆️	⬆️	⬆️	⬆️	0.9	0.5	900				•
Panasonic Home Chef 4-in-1 NN-CD87KS	60	\$480	⬆️	⬆️	⬆️	⬆️	⬆️	⬆️	⬆️	⬆️	1.2	0.8	1000	•	•		•
Sharp SMC1132CS	59	\$145	⬆️	⬆️	⬆️	⬆️	⬆️	⬆️	⬆️	⬆️	1.1	0.7	1000				•
Cuisinart CMW-110	59	\$200	⬆️	⬆️	⬆️	⬆️	⬆️	⬆️	⬆️	⬆️	1.1	0.6	1000				•
Toshiba ML2-EM31PASS	58	\$110	⬆️	⬆️	⬆️	⬆️	⬆️	⬆️	⬆️	⬆️	1.1	0.6	1000				•
Cuisinart CMW-100	57	\$180	⬆️	⬆️	⬆️	⬆️	⬆️	⬆️	⬆️	⬆️	1.0	0.7	1000				•
Farberware FMO11AHTBKB	53	\$100	⬆️	⬆️	⬆️	⬆️	⬆️	⬆️	⬆️	⬆️	1.1	0.6	1000				•
GE JES1097SMSS Smart	52	\$140	⬆️	⬆️	⬆️	⬆️	⬆️	⬆️	⬆️	⬆️	0.9	0.5	900	•			•
Black+Decker EM031MGGX1	52	\$85	⬆️	⬆️	⬆️	⬆️	⬆️	⬆️	⬆️	⬆️	1.1	0.6	1000				•
RCA RMW1138	44	\$80	⬆️	⬆️	⬆️	⬆️	⬆️	⬆️	⬆️	⬆️	1.1	0.7	1000				•
LARGE COUNTERTOP MICROWAVES																	
✓ Panasonic NN-SE785S	87	\$330	⬆️	⬆️	⬆️	⬆️	⬆️	⬆️	⬆️	⬆️	1.6	0.9	1250	•			•
✓ Panasonic NN-SD975S	83	\$250	⬆️	⬆️	⬆️	⬆️	⬆️	⬆️	⬆️	⬆️	2.2	1.5	1250	•			•
✓ Panasonic NN-SN966S	82	\$250	⬆️	⬆️	⬆️	⬆️	⬆️	⬆️	⬆️	⬆️	2.2	1.4	1250				•
✓ LG LMC1575	79	\$220	⬆️	⬆️	⬆️	⬆️	⬆️	⬆️	⬆️	⬆️	1.5	0.8	1200				•
✓ Panasonic NN-SD745S	78	\$220	⬆️	⬆️	⬆️	⬆️	⬆️	⬆️	⬆️	⬆️	1.6	0.9	1250	•			•
✓ Panasonic NN-SN736B	77	\$190	⬆️	⬆️	⬆️	⬆️	⬆️	⬆️	⬆️	⬆️	1.6	0.9	1250				•

Brand + Model	Overall Score	Price	Survey Results		Test Results					Specs			Features			
			Predicted reliability	Owner satisfaction	Heating evenness	Defrosting evenness	Speed of heating	Microwaving noise	Ease of use	Claimed capacity (cu. ft.)	Usable capacity (cu. ft.)	Watts	Detailed prompts	Convection mode	Sensor	Stainless/SS-look option
LARGE COUNTERTOP MICROWAVES <i>Continued</i>																
Amazon Smart Oven plus Echo Dot	76	\$250								1.5	0.8	1000				
GE Profile JES2251SJ	75	\$280								2.2	1.4	1200				
Sharp SMC2242DS	72	\$190								2.2	1.3	1200				
Toshiba EC042A5C-BS	70	\$195								1.5	0.8	1000				
Magic Chef MCM1611ST	70	\$130								1.6	0.9	1100				
GE Profile PES7227SLSS	70	\$350								2.2	1.3	1100				
Magic Chef MCD1811ST	69	\$140								1.8	1.1	1100				
Danby DMW14SA1BDB	69	\$150								1.4	0.7	1100				
Panasonic NN-SU 656B	68	\$150								1.3	0.7	1100				
GE JES2051SN[SS]	68	\$250								2.0	1.2	1200				
Electrolux EI24MO45IB	67	\$800								2.0	1.2	1100				
Oster OGYZ1602B	67	\$110								1.6	0.9	1100				
Farberware Smart Sensor Cooking FMO16AHTBSA	66	\$200								1.6	0.9	1300				
Panasonic NN-SD69LS	66	\$160								1.3	0.7	1100				
GE Profile PEB9159SJSS	66	\$665								1.5	0.8	1000				
Samsung MG14H3020CN	65	\$230								1.4	0.9	950				
Galanz ExpressWave	65	\$120	—	—						1.4	0.8	1100				
KitchenAid KMCS3022GSS	64	\$430								2.2	1.3	1200				
Samsung MS19M8000AS	61	\$190								1.9	1.2	950				
Sharp SMC1843CM	59	\$170								1.8	1.1	1100				
KitchenAid KMCS1016GSS	57	\$515								1.6	0.9	1200				
GE JES1460DSBB	57	\$140								1.4	0.9	1100				
Sharp SMC1452CH	56	\$160								1.4	0.7	1100				
Farberware FMO16AHTPLB	53	\$150								1.6	0.9	1100				
Samsung MS14K6000AS	50	\$170								1.4	0.9	1000				
Farberware Professional FMO13AHTPLE	50	\$150								1.3	0.7	1100				

Digital and All Access members can find the latest, complete ratings at [CR.org/microwaveratings](https://www.consumerreports.org/microwaveratings).

HOW WE TEST: Overall Score combines test results with survey data for predicted reliability and owner satisfaction. Predicted reliability estimates the likelihood that newly purchased models from a given brand will develop problems or break within the first five years. Owner satisfaction reflects the proportion of CR members who are extremely likely to

recommend the microwave they bought. In cases where we have insufficient survey data to provide a brand-level rating, indicated by a gray dash (—), we give the model weighted category average reliability and satisfaction scores. Heating evenness reflects how evenly a model reheated a dish of cold mashed potatoes. Defrosting evenness is based on how well the auto-defrost

program defrosted a pound of frozen ground beef. Speed of heating is based on the temperature rise of water that's heated. Microwaving noise reflects how quiet the appliance is while it's on high. Ease of use includes how easy it is to set the microwave without referring to the instructions. Venting (airflow) is based on the volume of air drawn in by the internal fan on the highest setting

of an over-the-range model. Usable capacity is the usable space based on our measurements, and excludes the corner spaces for models with rotating turntables. Note that most over-the-range models allow you to turn off the rotation to fit large dishes. With the rotation off, measured capacity approximates claimed capacity. Price is approximate retail.





Dishwashers

Dish Duty, Done

BETTER CLEANING USING LESS ENERGY AND WATER—SOUNDS IMPOSSIBLE, RIGHT? BUT THAT'S EXACTLY WHAT THE BEST DISHWASHERS IN OUR TESTS DELIVER. PLUS, MANY MODELS HAVE A SLEW OF CONVENIENCE FEATURES. USE THIS GUIDE TO HELP YOU FIND THE RIGHT ONE FOR YOU.

Using a dishwasher can save you more than 230 hours a year compared with washing and drying by hand, according to Energy Star. If you haven't bought a dishwasher in a while, you'll notice that they don't look as uniform as they once did. You'll find more finishes and sleek designs, some with hidden controls, no handles, and no brand logos. This helps a new dishwasher blend in with appliances from other brands. Here's what else you need to know.

● MAKING THE RIGHT CHOICE

Focus on these details while you're shopping.

DIMENSIONS

Conventional dishwashers are intended for a space measuring 24 inches wide by 24 inches deep. Installing your new dishwasher could be a challenge if you've tiled the floor or redone your counters, because that might change the height of the cavity. So measure your space and ask the retailer for the full height range, and allow extra space for the leveling feet.

STYLE

Cabinet-front dishwashers can accommodate a panel that blends in with your cabinets for an integrated, furniture-style look. Other options include a range of finishes and a recessed pocket handle instead of a standard one.

CONTROLS

Certain models have interactive touch controls, but the usual touchpads are fine if they're well marked. If controls are hidden when the door is closed, look for cycle-time and other outer displays, otherwise it

can be hard to tell that a quiet machine is on.

CONVENIENCE FEATURES

Many dishwashers have adjustable racks and lots of flatware slots. Certain midpriced models have a third rack for large utensils and small cups. Many have fold-down tines to help fit large dishes, and racks that move up or down for oversized items.

ENERGY EFFICIENCY

Dishwashers that are Energy Star-qualified use about 12 percent less energy than standard models and save water. The most miserly used only 4 to 6 gallons of water in our tests, which included the high-temperature wash and heated dry options when available.

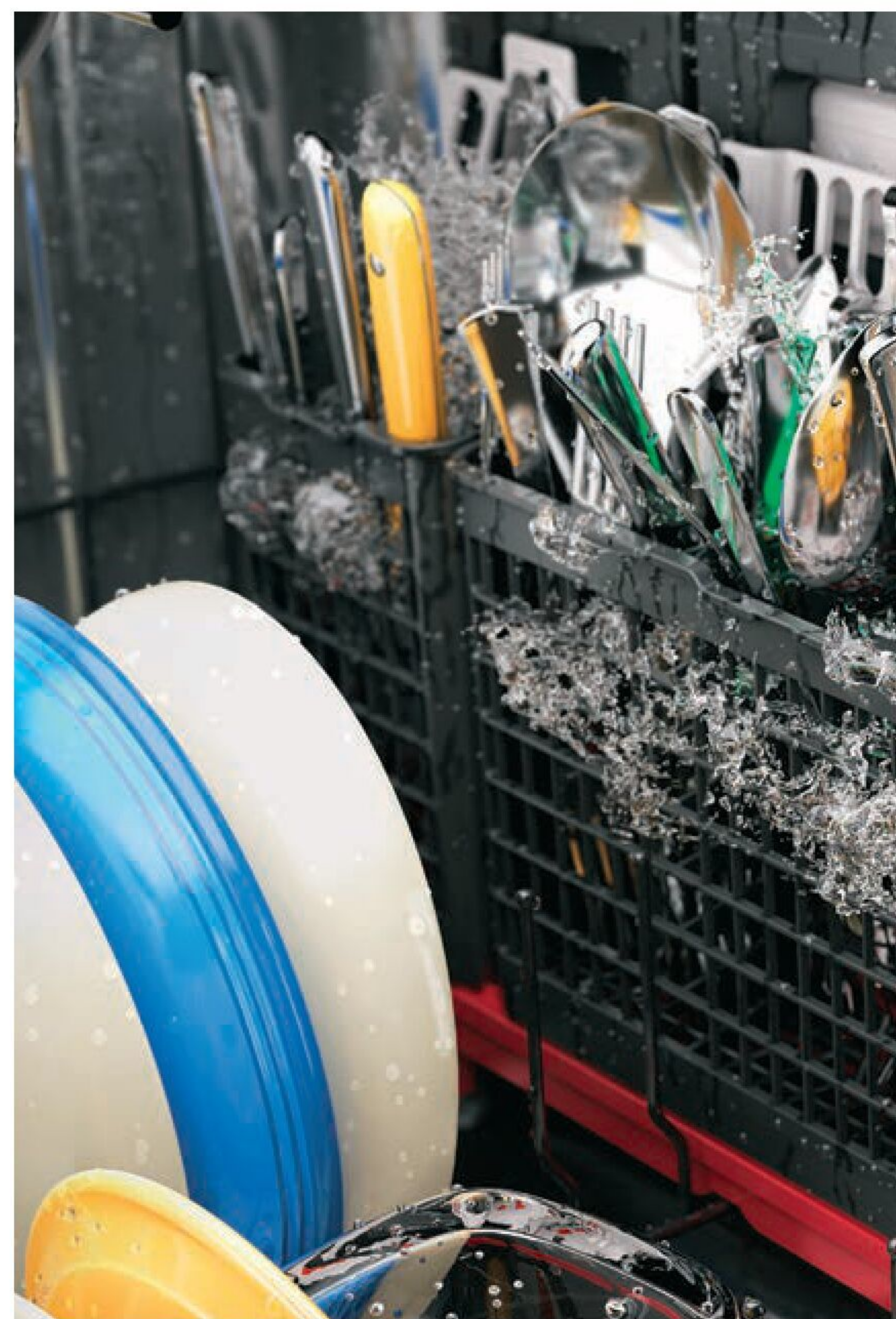

● FEATURES THAT MATTER MOST

These convenience features can make your dishwasher easier to use.

SOIL SENSORS

These adjust the cycle time and water use to the load's soil level, reducing energy demand and water use for more efficient loads.

ADJUSTABLE RACKS AND LOADING AIDS

Racks that move up and down, tines you can adjust, and silverware and stemware holders let you reconfigure the interior of a dishwasher

and organize its contents to fit large and odd-shaped items. Shop carefully and you're likely to get a third rack for large utensils and small cups, and not just in premium models.

FILTERS

These keep wash water free of food that could be redeposited onto clean dishes. There are two types: self-cleaning and manual. With self-cleaning filters, a grinder pulverizes debris and flushes it down the drain. That's convenient

but can be noisy. Certain models have a filter without a grinder. They're quieter, but you need to clean the filter periodically, a quick and easy job. Refer to your owner's manual to see which you have.

SPECIAL WASH CYCLES

Most dishwashers come with at least three cycles: light, normal, and heavy (for pots and pans), with many newer models also including "quick" or "express" cycles that clean lightly

soiled loads in as little as 20 minutes but don't dry the dishes. Some offer cycles, including pot scrubber, soak/scrub, steam clean, china/crystal, and sanitizing. And certain models have a half-load option, handy if you rarely have a full load. The three basic cycles should be enough for most chores, even for baked-on food. A sanitizing option that raises the water temperature above the typical 140° F doesn't necessarily deliver better cleaning for dishes. It's meant to disinfect the dishwasher's interior.

WASH ZONES

Certain models designate part of the dishwasher for heavily soiled items



MONEY SAVER

You can find a dishwasher for \$500 or less by sticking with the basics: three to four cycles, a plastic tub instead of stainless steel, non-adjustable racks, no third rack, and controls on the front (not on the top) of the door.



GE

needing a special cycle. In our tests, they seem to work as promised.

HEATED DRY

Dishwashers usually dry using drainage and the residual heat in the tub. Certain models will either heat the water further during the final rinse (to warm up the stainless tub) or use a heating element, perhaps coupled with a fan to circulate the air. A few models have the door open near the end of the cycle to aid in drying.

STAINLESS STEEL TUB

Stainless steel tends to resist staining better than light-colored plastic does. Gray plastic tubs help camouflage stains and trim the overall cost. Any

plastic tub should last longer than most people keep a dishwasher.

HIDDEN CONTROLS

Controls mounted along the top edge of the door (hidden when the door is closed) are strictly about style. The downside: You usually can't see cycle progress at a glance. Partly hidden controls are a good compromise. You'll know when the machine is running and sometimes the remaining cycle time.

QUIET PERFORMANCE

Some manufacturers display a decibel rating. But they average the sound level of an entire cycle (including the silent dry cycle), which can be a bit misleading.

● WHAT'S ON THE MARKET?

Take a close look at how the dishwasher's interior is configured—the spacing of tines and the placement of the silverware baskets and racks. You need a dishwasher that works for the dishes, cookware, and utensils you use.

DISHWASHERS FOR \$500 OR LESS

Although they aren't the top performers in our tests, you can still get a dishwasher that's excellent at cleaning and very good or even excellent at drying. Certain models in this price range now have a soil sensor, which adjusts the cycle's time and water use to the load's soil level, improving water efficiency. And some even have a stainless interior. But basic features, longer wash cycles, and noisier operation are likely.

DISHWASHERS FOR \$600 TO \$900

You can get a quieter machine, superb cleaning, and convenient features that might make it worth spending a bit more, such as adjustable racks and flexible flatware slots, along with a stainless tub, which tends to resist stains better than plastic. A soil sensor is a given.

DISHWASHERS FOR \$1,000 OR MORE

High-end dishwashers come with high-end styling and innovative features, such as special wash zones for heavily soiled items, and WiFi connectivity.

DISHWASHER DRAWERS

They typically have two stacked drawers that you can use simultaneously or separately. But they're expensive, and the ones we tested haven't impressed us with their performance.



Recommended Products

Almost all the models we tested clean well, are easy to load, and come in a stainless finish. They also use far less water and energy than washing by hand. The picks here are excellent overall performers, and most have a timed-start feature, a heavy-duty or pots and pans cycle, and self-cleaning filters. The ratings rank models by overall performance.



24-INCH

BOSCH ASCENTA SHX3AR75UC

Cycle Time: 95 min.
Water Usage: 4 gal.
\$700

89

The combination of superior performance and features that more commonly appear on pricier washers makes this model a great value. It scores very well for washing, drying, and quiet operation, and its 95-minute cycle for a normal wash is one of the shortest of any washer that CR tests. bosch-home.com



24-INCH

BOSCH 300 DLX SERIES SHS863WD5N

Cycle Time: 150 min.
Water Usage: 4 gal.
\$775

85

This midpriced model earns a Very Good rating for washing. Even though many competitors earn Excellent scores for this critical task, it's still one of the top-rated washers in the category overall. The reason: It's among the best at drying, it's relatively quiet, and Bosch dishwashers get top marks for reliability and satisfaction in CR surveys. bosch-home.com



24-INCH

BOSCH 100 SERIES SHXM4AY55N

Cycle Time: 150 min.
Water Usage: 5 gal.
\$750

84

This Bosch is one of the cheaper midpriced washers, but it rates among the best. It earns a Very Good score for washing, is among the best at drying, and is relatively quiet, too. Its Overall Score gets a boost because Bosch dishwashers get high marks for reliability and satisfaction in CR surveys. bosch-home.com



24-INCH

THERMADOR DWHD660WFP

Cycle Time: 155 min.
Water Usage: 4 gal.
\$1,800

84

This exceptionally quiet model earns a Very Good rating for cleaning heavily soiled dishes and an Excellent for drying. Its energy efficiency also rates Excellent. It does have a long cycle time, however, and you have to clean the filter manually. thermador.com



24-INCH

BOSCH BENCHMARK SHX89PW55N

Cycle Time: 155 min.
Water Usage: 4 gal.
\$1,620

83

This Bosch Benchmark commands a top price and is a top performer. Not that its cleaning ability is so extraordinary; it earns a Very Good for that, but many high-end models score even better. But it rates Excellent for both drying and very quiet operation, and Bosch dishwashers get top marks for reliability and satisfaction in CR surveys. Its 150-minute wash cycle is on the long side. bosch-home.com



18-INCH

MIELE DIMENSION G4720SCI

Cycle Time: 170.
Water Usage: 4 gal.
\$1,500

71

This 18-inch Miele may save space, but it won't save money—its very good performance comes with a high price. It does boast very good wash performance and excellent energy efficiency, and it's very quiet. But drying was just good and the filter must be cleaned manually. It has a host of convenience features, including a third rack, a delayed-start feature, and a time-remaining display. It requires a custom door panel. miele.com



18-INCH

WHIRLPOOL WDF518SAHM

Cycle Time: 130 min.
Water Usage: 5 gal.
\$815

71

This 18-inch Whirlpool offers a lot of value. It scores Very Good on CR's tests for both washing and drying, and boasts a reasonably fast cycle time. And on surveys, Whirlpool dishwashers get a very good mark for reliability. One negative: Noise was rated just mediocre, so it might be the best choice for a kitchen that's located near living spaces. whirlpool.com

Brand + Model	Overall Score	Price	Survey Results		Test Results				Features								
			Predicted reliability	Owner satisfaction	Washing	Drying	Energy use	Noise	Cycle time (min.)	Ample flatware slots	Adjustable upper rack	Adjustable tines	Displays remaining time	Interior material	Requires custom door panel	Self-cleaning filter	WiFi
\$ Bosch Ascenta SHX3AR75UC	89	\$700	↑	↑	↑	↑	↑	↑	95	●	●	●	●	Stainless steel and plastic			
✓ Bosch 300 DLX Series SHS863WD5N	85	\$775	↑	↑	↑	↑	↑	↑	150	●	●	●	●	Stainless steel			
✓ Bosch 100 Series SHXM4AY55N	84	\$750	↑	↑	↑	↑	↑	↑	150	●	●	●	●	Stainless steel and plastic			
✓ Thermador DWHD660WFP	84	\$1,800	↑	↑	↑	↑	↑	↑	155	●	●	●	●	Stainless steel			●
✓ Bosch Benchmark SHX89PW55N	84	\$1,615	↑	↑	↑	↑	↑	↑	155	●	●	●	●	Stainless steel			
✓ Thermador DWHD770WFM	83	\$2,300	↑	↑	↑	↑	↑	↑	150	●	●	●	●	Stainless steel			●
\$ Ikea Renlig IUD7070DS [288921]	83	\$550	↑	↓	↑	↑	↑	↓	115	●				Plastic			
✓ Bosch 800 Series SHXM88Z75N	82	\$1,090	↑	↑	↑	↑	↑	↑	150	●	●	●	●	Stainless steel			●
✓ Bosch 800 Series SHPM78Z55N	82	\$1,040	↑	↑	↑	↑	↑	↑	150	●	●	●	●	Stainless steel			●
✓ Bosch Benchmark SHX88PZ55N	82	\$1,600	↑	↑	↑	↑	↑	↑	150	●	●	●	●	Stainless steel			●
✓ Miele Classic Plus G4977SCVISF	82	\$1,200	↑	↑	↑	↑	↑	↑	150	●	●	●	●	Stainless steel			
✓ Bosch 300 Series SHEM63W55N	82	\$770	↑	↑	↑	↑	↑	↑	155	●	●	●	●	Stainless steel			
Bosch 800 Series SHPM78W55N	79	\$900	↑	↑	↑	↑	↑	↑	160	●	●	●	●	Stainless steel			
Miele Futura Crystal G6665SCVISF	79	\$1,800	↑	↑	↑	↑	↑	↑	140	●	●	●	●	Stainless steel			
Kenmore 14573	79	\$600	↓	↓	↑	↑	↑	↑	145		●		●	Stainless steel			
Bosch 800 Series SHXM98W75N	78	\$1,150	↑	↑	↑	↓	↑	↑	160	●	●	●	●	Stainless steel			
Kenmore 14523	77	\$630	↓	↓	↑	↑	↑	↑	150		●		●	Stainless steel			
Miele Dimension G6785SCVISF	76	\$1,900	↑	↑	↑	↑	↑	↑	145	●	●	●	●	Stainless steel			
Bosch 500 Series SHPM65W55N	76	\$815	↑	↑	↑	↓	↑	↑	160	●	●	●	●	Stainless steel			
GE Profile PDF820SSJSS	76	\$1,010	↓	↓	↑	↓	↑	↑	150	●	●	●	●	Stainless steel			
Bertazzoni DW24XT	76	\$1,105	—	—	↑	↓	↑	↑	135	●	●	●	●	Stainless steel			
Kenmore Elite 14793	76	\$900	↓	↓	↑	↓	↑	↑	145	●	●	●	●	Stainless steel			
Whirlpool WDF520PADM	75	\$520	↑	↓	↑	↓	↑	↓	115	●				Plastic			
GE Profile PDT855SSJSS	75	\$1,370	↓	↓	↑	↓	↑	↑	155	●	●	●	●	Stainless steel			●
Café CDT845P2NS1	74	\$1,100	↓	↓	↑	↓	↑	↑	155	●	●	●	●	Stainless steel			●
Thor Kitchen HDW2401SS	74	\$800	—	—	↑	↓	↑	↑	130	●	●	●	●	Stainless steel			
Kenmore 13223	74	\$550	↓	↓	↑	↑	↑	↓	160		●		●	Stainless steel			
KitchenAid KDPM604KPS	74	\$900	↓	↑	↑	↑	↑	↑	145	●	●	●	●	Stainless steel			●
Kucht K6502D	74	\$720	—	—	↑	↓	↑	↑	140	●	●	●	●	Stainless steel			
KitchenAid KDPE234GPS	74	\$1,000	↓	↑	↑	↓	↑	↑	135	●	●	●	●	Stainless steel			
Samsung DW80K7050US	73	\$700	↓	↓	↑	↑	↑	↑	130	●	●	●	●	Stainless steel			
Kenmore 13473	73	\$450	↓	↓	↑	↑	↑	↓	160		●		●	Plastic			

Ratings > Dishwashers

Brand + Model	Overall Score	Price	Survey Results		Test Results				Features							
			Predicted reliability	Owner satisfaction	Washing	Drying	Energy use	Noise	Cycle time (min.)	Ample flatware slots	Adjustable upper rack	Adjustable tines	Displays remaining time	Interior material	Requires custom door panel	Self-cleaning filter
24-INCH DISHWASHERS <i>Continued</i>																
Ikea VASKAD [50422663]	73	\$850	↑	↓	↑	↑	↑	↑	145	●	●	●	●	Stainless steel		
Ikea SPOLAD [80422355]	73	\$750	↑	↓	↑	↑	↑	↑	145	●	●	●	●	Stainless steel		
Ikea Renlig IUD7555DS [90292264]	72	\$550	↑	↓	↑	↓	↑	↑	160	●	●	●	●	Stainless steel		
LG LDT7808BM	72	\$1,250	↓	↓	↑	↑	↑	↑	145	●	●	●	●	Stainless steel		●
Whirlpool WDT730PAHZ	72	\$500	↑	↓	↑	↑	↑	↑	140	●	●	●	●	Stainless steel and plastic		
Whirlpool WDTA50SAKZ	71	\$720	↑	↓	↑	↓	↑	↑	150	●	●	●	●	Stainless steel		
Samsung DW80R7061UG	71	\$850	↓	↓	↑	↓	↑	↑	120	●	●	●	●	Stainless steel		
Maytag MDB4949SHZ	71	\$675	↓	↓	↑	↑	↑	↑	155	●				Stainless steel	●	
Whirlpool WDT970SAHZ	70	\$810	↑	↓	↑	↑	↑	↑	145	●	●	●	●	Stainless steel		
Miele Futura Lumen G6885SCVIK2O	70	\$2,300	↑	↑	↑	↑	↑	↑	170	●	●	●	●	Stainless steel	●	
Whirlpool WDF330PAHS	70	\$475	↑	↓	↑	↓	↑	↓	110					Plastic		
Samsung DW80R9950US	69	\$1,150	↓	↓	↑	↑	↑	↑	130	●	●	●	●	Stainless steel		●
GE GDP615HSMSS	69	\$635	↓	↓	↑	↓	↑	↓	155	●	●		●	Stainless steel and plastic		
GE Profile PDT715SYNFS	69	\$700	↓	↓	↑	↓	↑	↓	155	●	●		●	Stainless steel and plastic		
Midea MDT24H3AST	69	\$450	—	—	↑	↓	↑	↑	145	●	●	●	●	Stainless steel		
Bosch 800 Series SHEM78WH5N	69	\$1,260	↑	↑	↑	↓	↑	↑	165	●	●	●	●	Stainless steel		●
Kenmore Elite 14815	68	\$1,300	↓	↓	↑	↓	↑	↑	120	●	●	●	●	Stainless steel	●	
Kenmore Elite 14673	67	\$600	↓	↓	↑	↓	↑	↑	135	●	●	●	●	Stainless steel		●
Ikea LAGAN [00385804]	67	\$270	↑	↓	↑	↑	↑	↓	160					Plastic		
Maytag MDB8959SKZ	67	\$750	↓	↓	↑	↓	↑	↑	145	●	●	●	●	Stainless steel	●	
Maytag MDB4949SKZ	66	\$675	↓	↓	↑	↑	↑	↓	135	●			●	Stainless steel	●	
LG Signature LUDP8997SN	66	\$1,375	↓	↓	↑	↓	↑	↑	130	●	●	●	●	Stainless steel		
LG LDP6797ST	66	\$665	↓	↓	↑	↓	↑	↑	130	●	●	●	●	Stainless steel		
Samsung DW80R5060US	65	\$600	↓	↓	↑	↑	↑	↑	130	●	●	●	●	Stainless steel	●	
Whirlpool WDF130PAHW	65	\$280	↑	↓	↑	↑	↑	↓	160					Plastic		
Samsung Chef Collection DW80M9990US	65	\$1,300	↓	↓	↑	↑	↑	↑	130	●	●	●	●	Stainless steel		●
Frigidaire FFCD2413US	64	\$350	↓	↓	↑	↑	↑	↓	145					Plastic	●	
LG LDP6810BD	64	\$945	↓	↓	↑	↑	↑	↑	180	●	●	●	●	Stainless steel		
GE GDT655SSJSS	64	\$610	↓	↓	↑	↓	↑	↑	155	●	●	●	●	Stainless steel		
Frigidaire FFID2426TS	64	\$400	↓	↓	↑	↑	↑	↓	130			●		Plastic		
GE GDT695SSJSS	64	\$775	↓	↓	↑	↓	↑	↑	155	●	●	●	●	Stainless steel		
KitchenAid KDPE334GPS	63	\$1,050	↓	↑	↑	↓	↑	↑	160	●	●	●		Stainless steel		
Kenmore 13803	62	\$300	↓	↓	↑	↓	↑	↓	115					Plastic		

Brand + Model	Overall Score	Price	Survey Results		Test Results				Features							
			Predicted reliability	Owner satisfaction	Washing	Drying	Energy use	Noise	Cycle time (min.)	Ample flatware slots	Adjustable upper rack	Adjustable tines	Displays remaining time	Interior material	Requires custom door panel	Self-cleaning filter

24-INCH DISHWASHERS *Continued*

LG LDF5545ST	61	\$480							200					Stainless steel			
Samsung DW80M2020US	60	\$530							130					Stainless steel and plastic			
Samsung DW80R2031US	59	\$400							175					Stainless steel			
Frigidaire FGID2468UF	58	\$450							200					Plastic			
Amana ADB1500ADS	58	\$565							140					Plastic			
Samsung DW80N3030US	58	\$450							175					Stainless steel and plastic			
Amana ADB1400AGW	57	\$350							166					Plastic			
GE GDF630PSMSS	56	\$450							200					Plastic			
Frigidaire Gallery FGID2479SF	56	\$600							195					Stainless steel			
Frigidaire Gallery FGIP2468UF	56	\$430							200					Plastic			
Frigidaire LFID2459VF	56	\$900							205					Stainless steel			
Fisher & Paykel DD24DDFTX9N	53	\$1,400							180					Plastic			
GE GDT565SSNS	52	\$530							215					Stainless steel			
Electrolux IQ Touch EI24ID81SS	50	\$1,095							190					Stainless steel			
GE GSD2100VWW	48	\$340							110					Plastic			

18-INCH

Miele Dimension G4720SCI	71	\$1,500							170					Stainless steel			
Whirlpool WDF518SAHM	71	\$815							130					Stainless steel and plastic			
GE Profile PDT145SSLSS	63	\$900							125					Stainless steel and plastic			
Bosch 300 Series SPE53U55UC	58	\$775							135					Stainless steel			

HOW WE TEST: Overall Score combines test results with survey data for predicted reliability and owner satisfaction. Predicted reliability estimates the likelihood that newly purchased models from a given brand will develop problems or break within the first five years. Owner satisfaction reflects the propor-

tion of CR members who are extremely likely to recommend the dishwasher they bought. In cases where we have insufficient survey data to provide a brand-level rating, indicated by a gray dash (—), we give the model weighted category average scores for reliability and satisfaction. To score Washing

performance, we run the normal or equivalent cycle to clean a full load with 10 place settings. Drying performance is our assessment of how thoroughly a dishwasher dries plastic cups—a tough task—using our test cycle and a rinse aid, which improves drying. Energy use is based on our test cycle. A panel of

testers judge Noise levels by listening to each machine through its entire cycle. Cycle time, rounded to the nearest 5 minutes, is based on running the normal or equivalent cycle to clean a full load. Price is approximate retail.





Cabinets

Kitchen Storage Solutions

THE RIGHT KITCHEN CABINETS CAN MAKE THE DIFFERENCE BETWEEN A WORK SPACE THAT'S DISORGANIZED AND CROWDED AND ONE THAT'S BEAUTIFUL AND EASY TO WORK IN. HERE'S HOW TO PLAN AND SHOP FOR STORAGE THAT FITS YOUR SPACE AND BUDGET.

Cabinets can be your biggest expense when remodeling, accounting for up to 40 percent of your budget. So it's worth spending the time to find the organizing features you need and a look you'll love—at the right price. Consumer Reports doesn't test cabinets at this time, but our in-house experts can help you make smart decisions. Use this guide to shop and save.

● MAKING THE RIGHT CHOICE

Before you head to a showroom, determine what you can spend and think about how you use the space.

BUDGET

Cabinets fall into three categories: stock, semi-custom, and custom. Stock cabinets start around \$100 per linear foot, installed. (A typical kitchen has 25 to 30 linear feet of cabinets.) Home centers sell them fully assembled. Stores such as Ikea offer flat-pack versions that are put together on site. Semi-custom cabinets, which start around \$150 per linear foot, come in more configurations, so they'll fit your kitchen more precisely. Custom cabinets can cost \$500 or more per linear foot. They're crafted to your specs and can include personalized features.

STYLE

Your first decision is between framed and frameless. Framed

cabinets have a separate frame applied to the front of the cabinet box; doors and drawers are attached to that frame. Frameless cabinets, often referred to as European-style, eliminate the face frame; doors and drawers are attached directly to the cabinet box. That provides great accessibility and a more contemporary look. But the absence of a face frame can compromise rigidity. Some manufacturers compensate by using a thicker, stronger box, say, 3/4-inch plywood instead of 1/2-inch particleboard. For the European look in a framed cabinet, opt for a full-overlay door, which covers the frame.

STORAGE FEATURES

Accessories like pull-out shelves, drawer dividers, and appliance lifts can improve cabinet functionality, but they'll also increase the cost by 20 percent or more. You'll save money by keeping them to a minimum.



MONEY SAVER

Cabinet manufacturers often charge premium prices for interior organizers and door and drawer hardware. Save money by looking for storage accessories you can add yourself after installation and by purchasing knobs and pulls at a home center or online.



Pick Your Storage Accessories

Cabinet manufacturers offer a wide array of optional storage accessories, usually for an upcharge. Here are some that are worth considering:

- **Drawer dividers** for corralling small items, such as cooking utensils and flatware.
- **Pantry cabinets** that feature rollout trays and

adjustable door racks.

- **Slide-out wastebaskets** to keep trash easily accessible but neatly out of sight.
- **Message-center cabinets** that offer shallow storage for small items, such as keys, as well as an integrated dry-erase message board or bulletin board.

- **Toe-kick cabinets** that are installed between the floor and the base of a cabinet, perfect for holding shallow items such as cookie sheets, trays, and place mats.
- **Lift cabinets** with spring-loaded shelves that swing up and out to provide easy access to mixers and food

PHOTOS: KARYN MILLET (TOP); MARK LUND (BOTTOM MIDDLE); KIM SMITH (BOTTOM RIGHT)



● WHAT'S ON THE MARKET?

Kitchen cabinets can vary greatly in price. Here's a look at the three main types you'll see.

BASIC

Often called stock, they're inexpensive, off-the-shelf cabinets. Some are fully assembled; others will need to be assembled on site. Many are frameless, meaning the door has no lip or "reveal" around it.

PROS They're a money-saving choice if you aren't too picky about style options or don't demand a perfect fit. More of them have better drawers, solid-wood doors, and other once-pricey features. And we found basic cabinet models that held up better than some more expensive ones.

CONS Many basic boxes are thinly veneered particleboard rather than higher-quality plywood. Style and trim options, sizes, and organizing accessories are still limited. Figure on an hour or more of assembly for each set.

MIDLEVEL

These semi-custom models are a sound choice for most kitchens. Many are made with face-frame construction, where a solid-wood frame is visible around the door and drawers.

PROS Midlevel models offer many made-to-order custom options for size, materials, finish, moldings and other trim, and accessories such as range-hood covers. That can make them the best value overall because you'll get the look you want without a custom price.

CONS As with basic cabinets, features and quality can vary considerably. Boxes may be veneered particleboard rather than higher-quality plywood.

PREMIUM

Short of custom made-to-order cabinets, these semi-custom models offer the most style and storage options.

PROS They generally come with plywood boxes and other premium materials and hardware options. Widths may come in 1/4-inch increments rather than the typical 3 inches, so they can fit your space perfectly.

CONS Though generally less expensive than fully made-to-order custom units, models with the most features and of the highest quality can cost as much as certain full-custom units. So get a price from a local cabinetmaker before you place an order.

processors, then tuck away when they're not in use.

- **Cubby units** installed underneath wall cabinets to hold wine or water bottles.
- **Vertical dividers** that neatly shelve cookie sheets and trays on their sides. They can be a good way to fill gaps between stock cabinets.



● FEATURES THAT MATTER MOST

What separates a well-made cabinet from a cheap imitation? Here are the features to look for—and what to avoid.

1. HARDWARE

Full-extension drawer guides are better than integrated side rails or undermounted double-roller designs. Some cabinet models have a “soft close” feature that stops them from slamming shut. As for door hinges, in past tests we didn’t find any significant differences among the various types.

2. SHELVES

Look for ¾-inch plywood. Lesser-quality ⅝- or ½-inch particleboard may sag.

3. MOUNTING STRIPS

Ask the contractor to use ¾-inch hardwood strips or metal strips with bolt holes. Thinner wood, medium-density fiberboard, or particleboard can be a safety concern with heavily loaded wall cabinets.

4. DOORS

Most manufacturers offer a similar range of options at all their price levels. Look for a solid-wood frame surrounding solid-wood or plywood panels.

5. DRAWERS

Well-built drawers are critical because drawers get the most use. The best ones have solid-wood sides, dovetail joinery, and a plywood bottom that fits grooves on four sides. Avoid stapled particleboard.

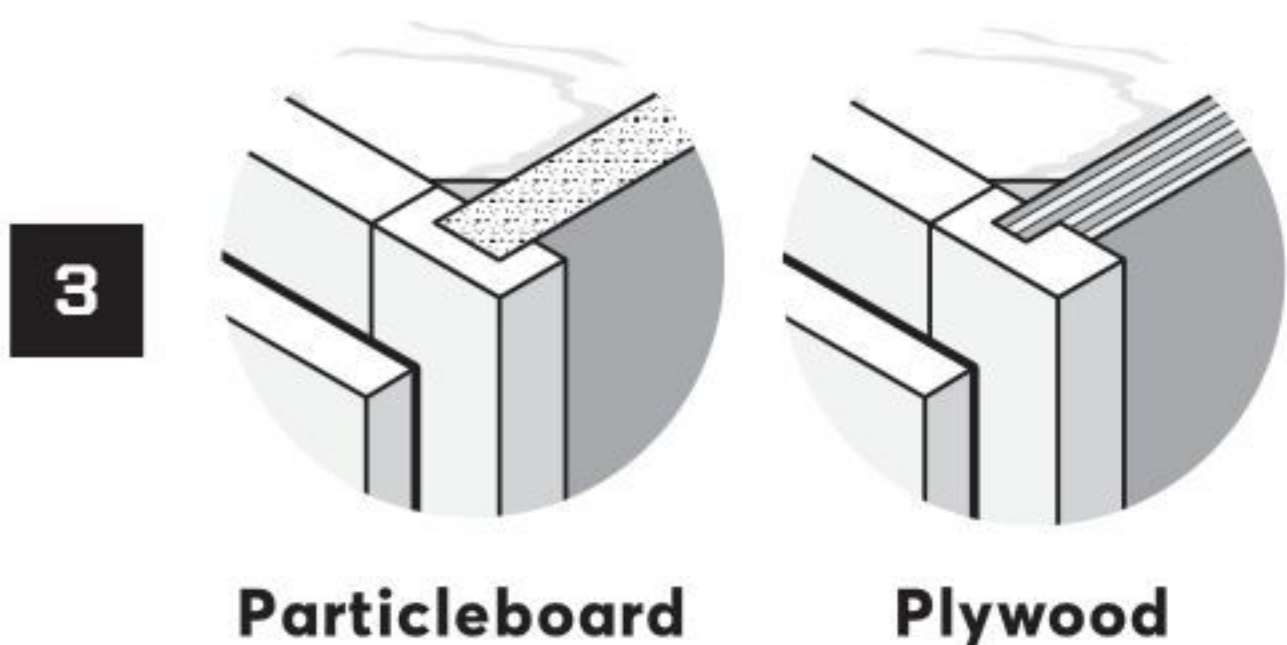
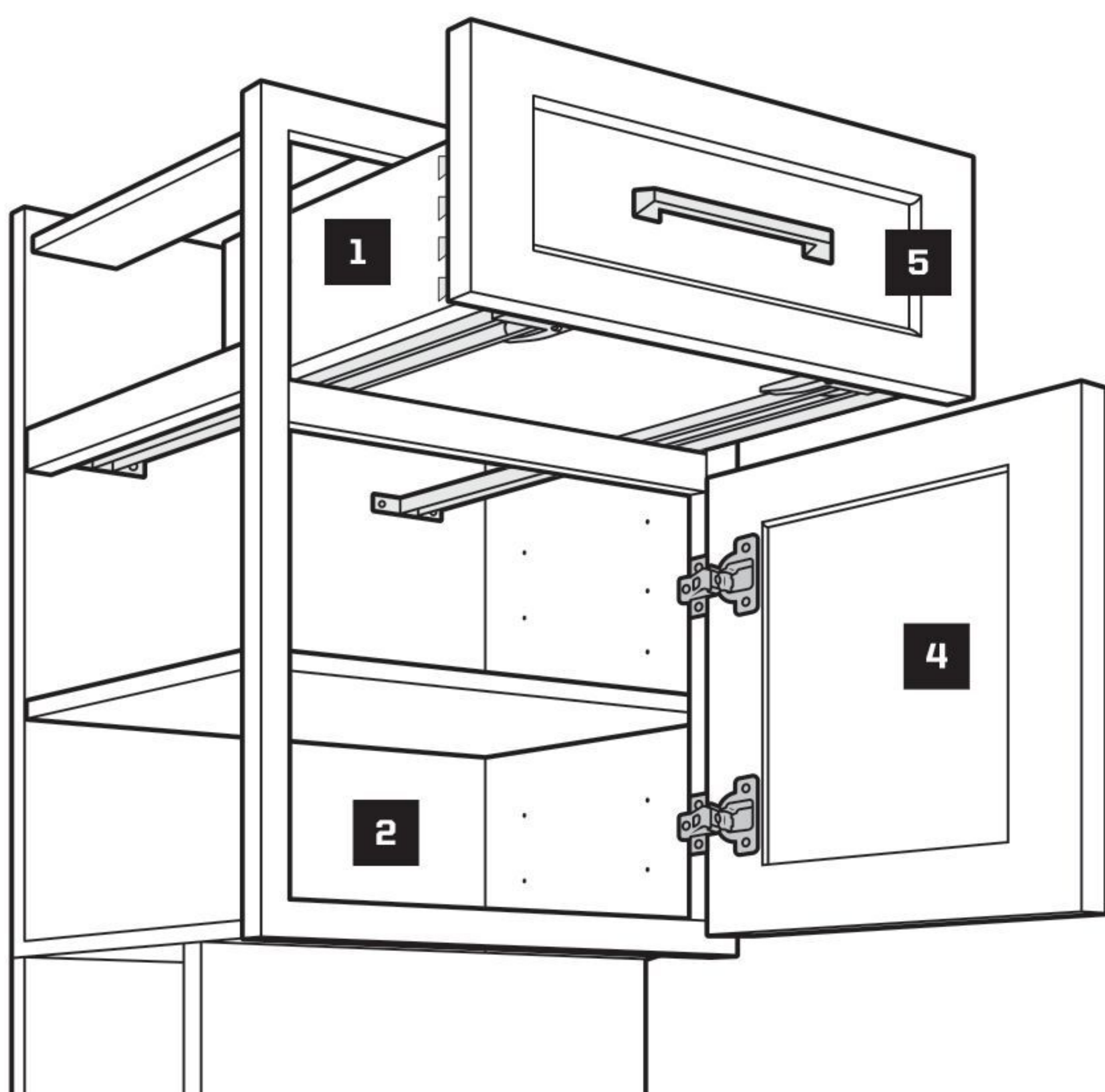

Particleboard

Plywood

Fake a Custom Look

If you’re buying budget-friendly stock or semi-custom cabinets, you don’t have to settle for the ordinary. Decorative design elements can give even basic stock cabinets a more personalized look in an array of styles, including country, modern, and traditional.

- **Accent doors**, available in a variety of styles—textured or colored, frosted glass, or stainless steel—can enhance visual interest or create an industrial look.

- **Moldings**, which range from simple to ornate, can be added to the top, bottom, or edge of cabinets as a finishing touch, or along the bottom of wall cabinets to conceal undercabinet lighting. Just be sure that the style you choose suits your cabinets and your home. Consider matching them to existing moldings or trim.

- **“Legs” (or feet)** added to the base of built-in cabinets create the trendy look of freestanding furniture. You can find decorative trim pieces, such as moldings, corbels, corner details, onlays, and turnings, for a great price at local lumber stores and home centers.



Choose a Winning Finish

The finish you choose for your cabinets can set the tone for your entire kitchen. Options include a clean and modern look for contemporary kitchens; deep rich wood for traditional elegance; and distressed finishes for a vintage effect.

The right choice for your kitchen depends on your



GET THE INSTALLATION RIGHT

When installers come to give an estimate, have a plan handy. That way they can account for the height and type of the new wall cabinets, the soffits, the location of electrical outlets and plumbing, and other variables. Make sure the estimate includes the removal and disposal of your existing cabinets and any other necessary demolition.

Before hiring an installer, talk with suppliers and, if possible, at least three former customers to find out how the work has held up. Ask for copies of the installer's insurance certificates as well. Certification from the National Association of the Remodeling Industry is a plus; it indicates a high level of professionalism.

For safety's sake, shore up the wall mountings. And be certain the installer reinforces the mounting strips if they're made of thin particleboard.

personal style—and your family's lifestyle.

"The white kitchen is a true classic," says Susan Serra, a certified kitchen designer, certified aging-in-place specialist, and author of *The Kitchen Designer* blog.

"And it's popular today as an easy look that can be

used to interpret any kitchen design theme."

If you prefer a more natural look, consider a finish that reveals the wood grain of the cabinet rather than obscuring it. Glazed finishes, for example, add soft, translucent color on top of the wood but allow the beauty of the grain to show

through. But that finish often comes at a premium price.

For those in the market for something a bit more modern, matte and high-gloss finishes are available in almost every color, not to mention trendy metallics, black, and white.

If you can't choose just one finish, create a layered look by

combining two or more—a modern look that adds a custom flair. To complement a natural-wood finish, for example, add an accent cabinet in an opaque color such as pale yellow or blue, or in a neutral. Or go bold in one area, such as on the base of the island.





Surface Report

IF YOU WANT THE SLEEK LOOK OF MARBLE OR CONCRETE WITHOUT THE MAINTENANCE PROBLEMS, YOU'RE IN LUCK. OUR TOP-RATED COUNTERTOP MATERIALS OFFER THE WINNING COMBINATION OF BEAUTY AND DURABILITY IN A WIDE RANGE OF STYLES.

We stained, sliced, scratched, scorched, and nicked 14 countertop materials to test how well they'll stand up to use in a kitchen. Spoiler alert: Quartz continues to impress our testers on every front. The manufactured stone offers a look that's realistic, resembling even rare and delicate materials surprisingly well. But it's not the only option that's durable. Old favorites like granite and laminate also took their share of abuse on the chin. Read on for all the details.

● MAKING THE RIGHT CHOICE

Use these important tips as you shop.

GET A SIZABLE SAMPLE

Tiny swatches or pictures can't give you a good sense of how a countertop material will look in your kitchen. So ask for a sample that's as large as the retailer can get. For natural stone, such as granite or marble, be sure to see the actual slab that will become your countertop before installation. Veining and pattern can vary from slab to slab.

CONSIDER RESALE

Grout lines between tiles are easily stained, and that may turn off potential buyers. Stone counters tend to look impressive and could raise your home's selling price.

DON'T MEASURE YOURSELF

If the installer does the measuring, they're responsible for any mistakes. Make sure the contract states the counter thickness, finish, and edge and backsplash treatments.



MONEY SAVER

Mix high- and lower-priced materials in the same space. You could use quartz or granite on high-impact areas (like the center island), for example, and less-expensive laminate on the perimeter.





● FEATURES THAT MATTER MOST

Seemingly small details can make a difference in looks and performance.

EDGE

You'll have several options for the edge treatment of your counters. Trimming laminate counters with wood can create a higher-end look and prevent chipping. For stone counters, rounded edges are less likely to chip. Straight and beveled edges give a more modern look, and an S-shaped curve, an ogee, offers stone or solid surfacing a more traditional feel. Some treatments add to the cost, so check with the supplier first.

FINISH

Quartz and granite are sold with a polished (glossy) or honed (matte)

finish. In our tests, both were about the same at holding up to stains that were allowed to dry overnight. Less common are leather and pebbled finishes. Granites with proprietary sealers performed no better than regular granite. Matte and grain finishes help conceal scratches in stainless steel better than polished finishes, but expect to see fingerprints. Quartz performed similarly regardless of the finish, but butcher block and concrete counters performed differently in our tests depending on the sealer used.

SEAMS

The joints between two slabs of stone or other kinds of material can make or break the look of a countertop. They should be almost

invisible in solid-surface and stainless steel countertops. For other countertop materials, seams that are 1/16 inch or less are standard. Wide joints can trap food and grime, and they're a telltale sign of sloppy installation.

SINK

Top-mounted sinks, also called drop-ins, sit on top of a counter. Undermount sinks are installed under a countertop and require a waterproof countertop material, such as quartz, stainless steel, solid surfacing, or concrete. Stainless steel and solid surfacing can be used for a countertop and sink. Check to make sure that the fabrication and installation contracts make note of your sink and faucet configurations.

FIND YOUR EDGE

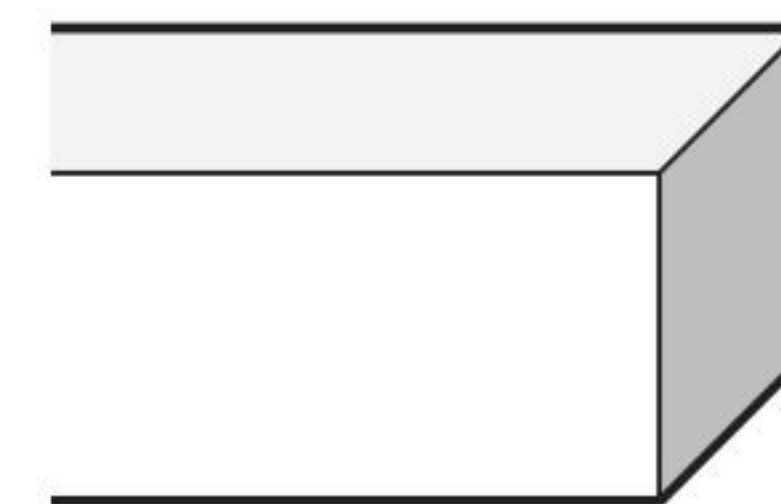

STRAIGHT PROFILE



EASED PROFILE

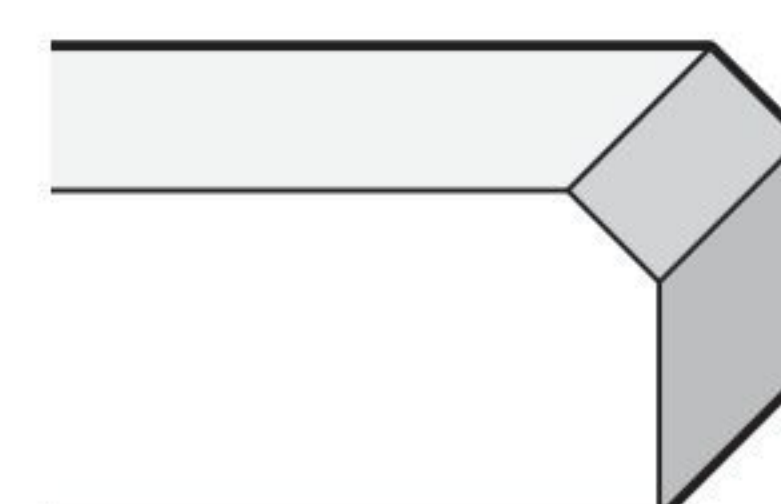

BEVELED PROFILE



BULLNOSE PROFILE

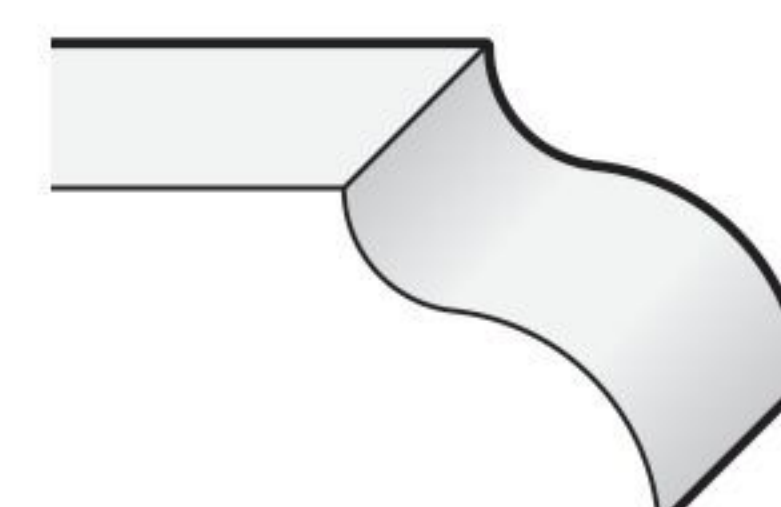

SHORT OGEE PROFILE

The Worst Stains for Every Surface

You might expect mustard and grape juice to be in a lineup of the worst offenders in countertop stains. But of the 20 household products in our stain tests, food coloring and permanent marker proved to be the toughest to wash away. Many things stain bamboo, and limestone and oil-rubbed butcher block don't fare well, either. Here's what left visible marks on six countertop materials.

BAMBOO (BEESWAX/ MINERAL-OIL FINISH)

Beet juice, coffee, crayon, drain cleaner, food coloring, pencil, permanent marker, rust, and tea.

CONCRETE (WITH PENETRATING SEALER)

Food coloring, hot oil, permanent marker, and shoe polish.

RECYCLED GLASS

Food coloring.

MARBLE

Food coloring and shoe polish.

STAINLESS STEEL

Drain cleaner and tarnish remover.

TILE

Food coloring, crayon, ink, permanent marker, and rust.

What's On the Market?

We've found that there's little variation among brands, so we rate materials instead. It's important to note that in some instances, a particular finish can affect a material's performance. That's why you'll see certain materials listed more than once in our ratings on the facing page.

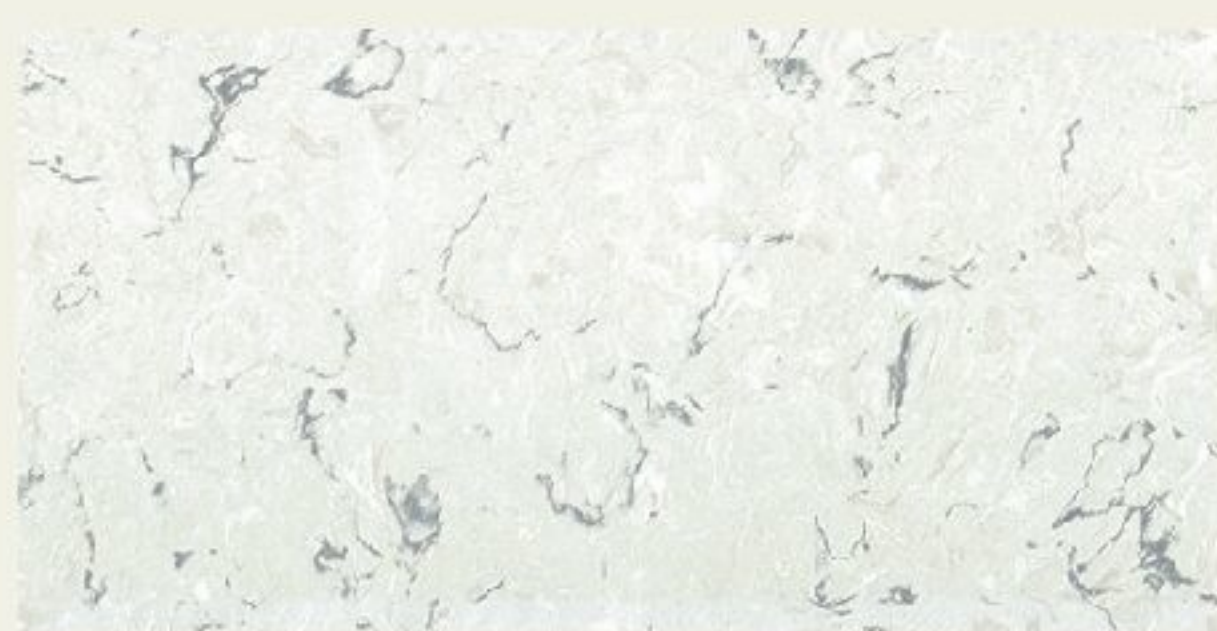

QUARTZ
\$20 TO \$60 PER SQUARE FOOT*

84

PROS A combination of mineral, color, and resin, quartz stands up well to cuts, abrasion, and heat. It comes in vibrant colors and patterns that look like granite and marble.
CONS Edges and corners can chip, and you'll need a pro to repair them.

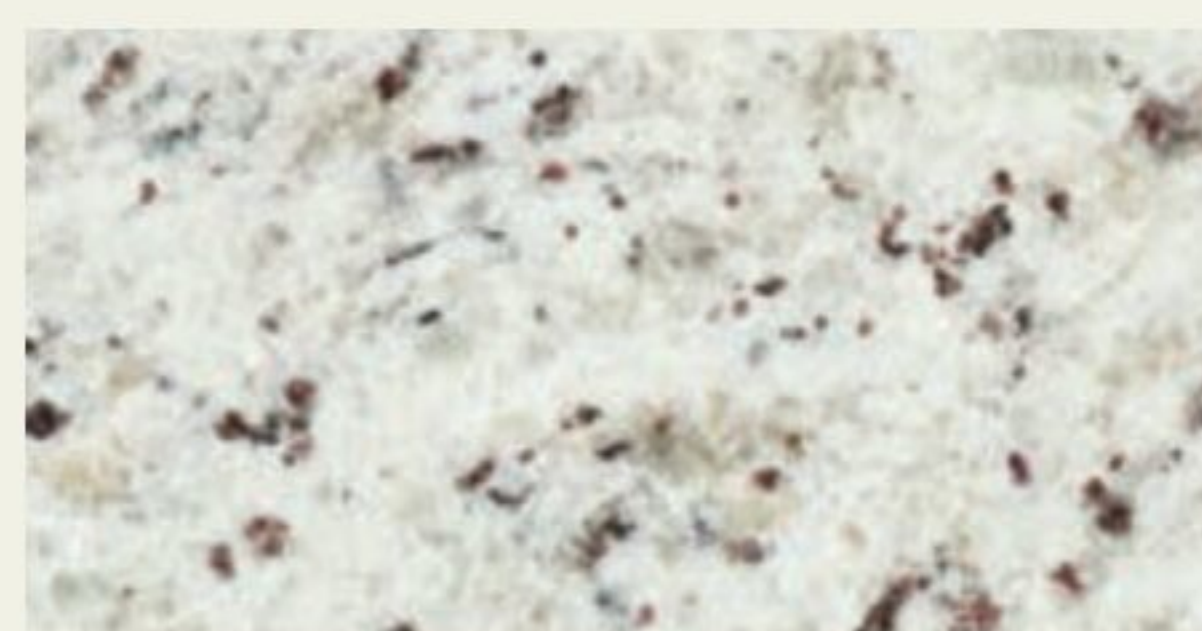

GRANITE
\$20 TO \$60 PER SQUARE FOOT*

81

PROS Each slab of this natural stone is different. Heat, cuts, and scratches didn't harm it in our tests. Polished and matte finishes resist most stains when properly sealed.
CONS Needs periodic resealing. Chips must be professionally repaired.



RECYCLED GLASS
\$25 TO \$100 PER SQUARE FOOT*

69

PROS Available in many colors, with large or fine particles. Most recycled glass resists stains, cuts, scratches, and heat.
CONS It's the only material for which we found a difference among brands. Cosentino's Eco counters were the only ones that cracked during our heat tests.



TILE (CERAMIC AND PORCELAIN)
\$5 TO \$20 PER SQUARE FOOT*

67

PROS Tile is water-resistant, heat-resistant, and ideal for use near stoves. It comes in many colors, sizes, and patterns.
CONS It chips. The grout between tiles can stain even when it's sealed, and it can mildew. Thinner grout lines and darker grout may help somewhat.



ULTRACOMPACT
\$50 TO \$100 PER SQUARE FOOT*

63

PROS We tested Dekton, a combination of quartz, porcelain, and glass, according to the manufacturer. It resisted damage from heat, stains, chopping and cutting, and abrasion.
CONS The material sustained chips to the edges and cracked into two in our impact tests.



SOLID SURFACING
\$15 TO \$50 PER SQUARE FOOT*

53

PROS Available in a range of colors and patterns, it can be used for counters, sinks, and backsplashes. Color won't vary much from sample to slab. It resists most stains. Small nicks and scratches can be repaired.
CONS It scratches and cuts easily, so use a cutting board.



SOAPSTONE
\$20 TO \$70 PER SQUARE FOOT*

46

PROS Best for adding the look of stone to a low-traffic kitchen. It withstands heat very well, and small scratches can be repaired. Slabs can vary widely.
CONS It's easy to slice, nick, and scratch. Stain resistance is fair. It must be rubbed with mineral oil periodically.



STAINLESS STEEL
\$20 TO \$60 PER SQUARE FOOT*

39

PROS It repels stains and heat, and doesn't rust or discolor. Countertops can include an integral sink for a seamless appearance.
CONS It shows fingerprints, and dents and scratches easily. Matte and grain finishes hide damage better.



BUTCHER BLOCK (VARNISHED)
\$20 TO \$60 PER SQUARE FOOT*

37

PROS It creates a warm, natural look in a kitchen and is easy to install and repair.
CONS It may need periodic sealing or refinishing to remove cuts, dings, and scratches. Its finish affects performance. Varnish improves stain resistance, and penetrating oils decrease it.



LIMESTONE
\$25 TO \$75 PER SQUARE FOOT*

27

PROS Limestone provides a stone look without heavy veining, and it resists heat well.
CONS Soft and porous, it scratches and dents easily. Eleven of the 20 substances we applied left visible stains after they were on the surface for just 24 hours, despite sealing.

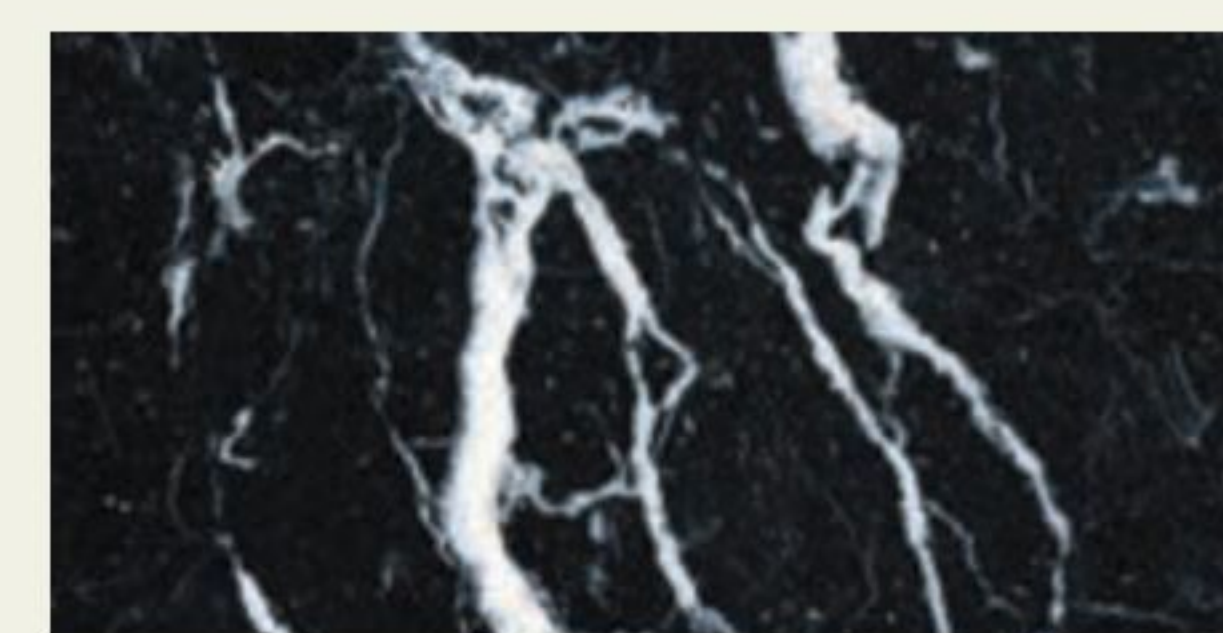

MARBLE
\$25 TO \$75 PER SQUARE FOOT*

14

PROS Marble is best for a classic look in low-traffic areas.
CONS It's more porous than granite, so it's not as stain-resistant. It also scratches easily, can chip, isn't very heat-resistant, and needs to be resealed regularly to prevent stains.



LAMINATE
\$5 TO \$25 PER SQUARE FOOT*

68

PROS It's inexpensive, easy to install, and much better-looking than you probably remember, thanks to new printing technology and decorative edges. Stains and heat didn't damage the laminates we tested.

CONS Cutting directly on laminate damages the surface.



CONCRETE (TOPICAL SEALER)
\$25 TO \$75 PER SQUARE FOOT*

39

PROS It can be dyed or fabricated with a surface texture.

CONS It may crack. Durability depends on the fabricator's skill and the sealing method. Topical sealers resist stains but not heat. Penetrating sealers resist heat but not stains and require periodic reapplication.



BAMBOO
\$20 TO \$60 PER SQUARE FOOT*

10

PROS Available in several styles, including a parquet pattern.

CONS Bamboo is easily stained, scorched, sliced, and nicked. The manufacturer might warn against using it around a sink because moisture can warp the material. And it might darken over time.

Material	Overall Score	Price	Test Results				
			Stains	Cutting	Heat	Abrasion	Impact
Quartz (engineered stone)	84	\$20-\$60	⬆	⬆	⬆	⬆	⬇
Granite	81	\$20-\$60	⬆	⬆	⬆	⬆	⬇
Recycled Glass (penetrating sealer)	69	\$25-\$100		⬆	⬆	⬆	⬇
Laminate	68	\$5-\$25	⬆	⬇	⬆		⬆
Tile (ceramic and porcelain)	67	\$5-\$20	⬇	⬆	⬆	⬆	
Ultracompact (Dekton)	63	\$50-\$100	⬆	⬆	⬆	⬆	⬇
Solid Surfacing	53	\$15-\$50	⬆	⬇	⬆	⬇	⬆
Soapstone (mineral-oil finish)	46	\$20-\$70		⬇	⬆	⬇	⬇
Concrete (penetrating sealer)	40	\$25-\$75	⬇		⬆	⬇	⬇
Concrete (topical sealer)	39	\$25-\$75	⬆	⬇	⬇		⬇
Stainless Steel	39	\$20-\$60		⬇	⬆	⬇	⬇
Butcher Block (varnished)	37	\$20-\$60	⬆	⬇	⬇	⬇	⬇
Limestone	27	\$25-\$75	⬇	⬇	⬆	⬇	⬇
Butcher Block (oil finish)	24	\$20-\$60	⬇	⬇	⬆	⬇	⬇
Marble	14	\$25-\$75	⬇	⬇	⬇	⬇	⬇
Bamboo (beeswax/mineral-oil finish)	10	\$20-\$60	⬇	⬇	⬇		⬇

HOW WE TEST: **Stains** shows resistance to 20 common foods and household products. **Cutting** reflects resistance to damage from weighted chef's and serrated knives used in slicing and chopping motions. **Heat** gauges how well

materials resisted damage and discoloration from a pot filled with oil heated to 400° F. **Abrasion** is resistance to damage from a weighted sanding block. **Impact** reflects the ability to withstand blunt and pointed weights dropped from

up to 3½ feet. **Price** is the typical range per square foot for the material only. Installation costs vary by region, material, and total scope of project. **Overall Score** summarizes performance in all tests.





Top Floors

A NEW MATERIAL UNDERFOOT CAN GIVE YOUR KITCHEN A DRAMATICALLY DIFFERENT LOOK, HELP LINK IT TO ADJOINING SPACES, AND MAKE CLEANING EASIER. HERE'S HOW TO CHOOSE THE RIGHT TYPE FOR YOUR SPACE AND YOUR BUDGET.

Installing a new floor is one of the more expensive updates you'll undertake. With so many choices—wood, vinyl, laminate, tile—where do you begin? Your budget is certain to guide your decision. But you should also consider how much foot traffic and sunlight your flooring will endure. To help you pick, we put the most common types and brands through a battery of tests. Use our ratings to select the floor that's best for your kitchen.



● CHOOSING THE RIGHT TYPE

Use these tips to pick the best flooring for your lifestyle.

TRAFFIC

In busy areas, choose a product that aced our foot-traffic tests.

UV AND WATER RESISTANCE

If your kitchen is in a sunny spot, a good UV resistance score could help prevent fading over time. And water resistance is important in any damp area.

CERTIFICATION

Vinyl floors with the industry's FloorScore certification emit relatively low levels of volatile organic compounds, substances

that have been linked to health problems and pollution. For wood flooring, certification by the Forest Stewardship Council and the Sustainable Forestry Initiative indicate that it comes from responsibly managed forests. Check the packaging for product and manufacturer certification.

SMOOTHNESS

The surface of flooring can vary, from styles that are perfectly smooth (even if they look grainy) to those with grooves that follows the design. If you're trying to replicate the look of wood with another material—vinyl, say—a more textured

style might seem like a good idea. Just keep in mind that these can be more likely to trap dirt and grime.



MONEY SAVER

The best wood-look vinyl and porcelain tile appear surprisingly like the real thing, but perform better and cost only half as much as solid or even engineered wood flooring.

● WHAT'S ON THE MARKET?

Before you buy, consider the pros and cons of each material.

CERAMIC TILE

BEST FOR projects with a bigger budget, though newer floating varieties are more affordable. There's a wide variety of styles, and tile tends to resist wear.

BUT most can't be floated and are difficult to install. Dropped items can crack it, and grout can stain. Replacing damaged tiles is tricky.

VINYL

BEST FOR practicality and easy installation. Many products stand up to damage from moisture, dents, stains, and sun.

BUT it can't pass for a natural material up close. Deep scratches will show the color of the vinyl beneath the decorative top layer.

LAMINATE

BEST FOR toughness, variety of styles, and easy installation. It can usually be floated. The best wear well, and most resist stains and UV.

BUT most dent fairly easily, and laminate can't be refinished.

SOLID WOOD AND BAMBOO

BEST FOR natural warmth. Solid flooring can usually be sanded and refinished several times. Prefinished floors can hold up

better than those finished on-site. And their warranty comes from the factory, not the installer, giving you the guarantee of a big company.

BUT solid wood will expand and contract with humidity, so it's not a good choice for damp spaces. And it can dent easily. Certain species can show wear quickly and become discolored from sunlight. Unfinished flooring costs less than prefinished, but higher installation costs can offset savings.

ENGINEERED WOOD AND BAMBOO

BEST FOR a warm look and easy installation. This veneer over substrate can usually be nailed, stapled, or glued in place, or "floated" over a subfloor without fasteners or glue. Many can be refinished. Well-installed, high-quality products can be as durable as solid wood.

BUT most show wear and dent easily, and some can be damaged by moisture.

LINOLEUM

BEST FOR those who want a sustainable, resilient surface. **BUT** vinyl tiles offer better performance. All-access and digital members can find ratings for linoleum flooring at cr.org/flooring.

Brand + Model	Overall Score	Price	Test Results							Features					
			Resists foot traffic	Resists scratches	Resists stains	Resists dents	Water resistance	Resistance to slipping	Resists sunlight (UV)	Sq. ft. per box	Surface smoothness	Installation	Light shades	Medium shades	Dark shades
PORCELAIN TILE FLOORING															
LifeProof Shadow Wood LP33624HD1PR (Home Depot)	93	\$2.00	↑	↑	↑	↑	↑	↑	↑	15	Textured	Thinset	●	●	●
Style Selections (Lowe's) Natural Timber Ash 553878	92	\$4.00	↑	↑	↑	↓	↑	↑	↑	10	Smooth	Thinset	●	●	●
Marazzi Montagna Dapple Gray ULM7 (Home Depot)	92	\$1.50	↑	↑	↑	↑	↑	↑	↑	15	Textured	Thinset	●	●	●
Lumber Liquidators Avella Ultra Brass Haven Oak 10043962	79	\$3.90	↑	↑	↑	↓	↑	↑	↑	8	Slight texture	Thinset		●	
Dal-Tile Forest Park Timberland FP97	72	\$7.00	↓	↑	↑	↑	↑	↑	↑	13	NA	Thinset	●	●	●
VINYL FLOORING															
Congoleum DuraCeramic Sierra Slate SI74 Golden Greige	85	\$5.00	↑	↑	↑	↑	↑	↑	↑	17	Slight texture	Glue	●	●	●
Armstrong Alterna Mesa Stone Canyon Sun D4112	83	\$5.50	↑	↑	↑	↑	↑	↑	↑	25	Textured	Glue	●	●	●
Armstrong Vivero D10 Homespun Harmony Rugged Brown U1042	83	\$4.00	↑	↓	↑	↑	↑	↑	↑	36	Smooth	Floating or glue	●	●	●
Armstrong Pryzm Elements of Heritage Vintage Multi PC020	82	\$5.30	↑	↓	↑	↑	↑	↑	↑	22	Smooth	Floating	●	●	●
Shaw Matrix Regency Gunstock Oak LX90100706 (Lowe's)	78	\$2.00	↑	↓	↑	↑	↑	↑	↑	28	Very textured	Floating	●	●	●
SmartCore Ultra Blue Ridge Pine 50SLVF603 (Lowe's)	69	\$3.30	↓	↓	↑	↑	↑	↑	↑	16	Textured	Floating	●	●	●
Lumber Liquidators CoreLuxe Ultra Rose Canyon Pine 10043266	67	\$4.10	↓	↑	↑	↑	↑	↑	↑	15	Very textured	Floating or glue	●	●	●
Armstrong LUXE Plank Timber Bay Barnyard Gray A6861	65	\$5.50	↓	↑	↑	↑	↑	↑	↓	24	Textured	Floating	●	●	●
Mohawk Woodlands Vintage Charm MHKIV039392	61	\$3.00	↓	↑	↑	↑	↑	↑	↑	19	Slight texture	Floating	●	●	●
TrafficMaster Khaki Oak 185312 (Home Depot)	60	\$1.80	↓	↓	↑	↑	↑	↑	↑	24	Slight texture	Floating	●	●	
Shaw Floorte PRO Paramount 512G Plus 510SA Ginger Oak 00802	57	\$3.20	↓	↓	↑	↑	↑	↑	↑	28	Slight texture	Floating or glue	●	●	●
SmartCore SCU XL Southern Pecan LX93707206 (Lowe's)	56	\$3.80	↓	↓	↑	↑	↑	↑	↑	18	Very textured	Floating or glue		●	
Mannington Black Mountain Oak Fireside 080171	55	\$1.50	↓	↓	↑	↑	↑	↑	↑	NA	Very textured	Floating or glue		●	●
Home Legend Oak Graphite HLVT3024 (Home Depot)	52	\$2.80	↓	↓	↑	↑	↑	↑	↑	23	Textured	Floating			●
Stainmaster Washed Oak 737998 (Lowe's)	51	\$2.50	↓	↓	↑	↑	↑	↑	↑	19	Slight texture	Floating	●	●	
LifeProof Nashville Oak I106514L (Home Depot)	51	\$3.00	↓	↓	↑	↑	↑	↑	↑	20	NA	Floating	●	●	●
Lumber Liquidators CoreLuxe XD Petrified Cherry 10046597	48	\$2.80	↓	↓	↓	↑	↑	↑	↑	22	Slight texture	Floating or glue		●	
ProCore Plus Warm Honey Oak LWD8099RCB (Lowe's)	47	\$2.40	↓	↓	↑	↑	↑	↑	↑	23	Slight texture	Floating	●	●	●
PREFINISHED SOLID WOOD FLOORING															
Teragren Portfolio Naturals Wheat TPF-PORTTG-WHT	71	\$7.50	↓	↑	↑	↑	↑	↑	↓	22	Smooth	Floating	●	●	●
Lumber Liquidators Bellawood Character Red Oak 10047316	69	\$4.50	↑	↓	↑	↓	↑	↑	↓	21	Smooth	Nail or glue	●	●	●
Armstrong Paragon Original Ember SAKP59L401	68	\$7.00	↑	↓	↑	↓	↑	↑	↑	24	Smooth	Nail	●	●	●
Lumber Liquidators Bellawood Natural Hickory 10034423	64	\$6.50	↑	↓	↑	↓	↑	↑	↓	22	Smooth	Nail or glue	●	●	●
Lumber Liquidators Bellawood Iron Hill Maple Character 10047324	61	\$5.50	↑	↓	↑	↓	↑	↑	↓	21	Smooth	Nail or glue		●	

ALERT Prefinished solid wood, vinyl, and tile flooring are better choices when it comes to formaldehyde emissions. Just be sure to use glues that don't contain the gas when installing these materials. Engineered wood and laminate flooring products are made with glues and resins that can emit formaldehyde.

Brand + Model	Overall Score	Price	Test Results							Features					
			Resists foot traffic	Resists scratches	Resists stains	Resists dents	Water resistance	Resistance to slipping	Resists sunlight (UV)	Sq. ft. per box	Surface smoothness	Installation	Light shades	Medium shades	Dark shades
PREFINISHED SOLID WOOD FLOORING <i>Continued</i>															
Blue Ridge Hardwood Flooring Red Oak Natural 20473 (Home Depot)	52	\$3.40	↓	↓	↑	↓	↑	↑	↓	18	Smooth	Nail or staple	•	•	•
Bruce Plano Oak Saddle AHS5117 (Home Depot)	42	\$4.00	↓	↓	↑	↓	↑	↑	↑	24	Smooth	Nail	•	•	•
ENGINEERED WOOD FLOORING															
Lumber Liquidators AquaSeal 72 Engineered Bamboo Water Resistant Click Strand Toffee 10046516 ¹	80	\$7.00	↑	↓	↑	↓	↑	↑	↑	15	Slight texture	Floating or glue		•	
Lumber Liquidators Bellawood Geneva White Oak 10045563	71	\$7.00	↑	↓	↑	↓	↑	↑	↓	24	Slight texture	Nail, glue or floating		•	
Bruce Hydropel Oak Parchment EKWR54L20W (Home Depot)	58	\$3.75	↓	↓	↑	↓	↑	↑	↑	23	Textured	Floating or glue	•	•	•
Malibu Wide Plank French Oak Stinson HDMPCL138EF (Home Depot)	56	\$2.60	↓	↓	↑	↓	↑	↑	↑	24	Textured	Floating or glue	•	•	•
SmartCore Naturals Timber Creek Oak LX54904001 (Lowe's)	54	\$4.00	↓	↓	↑	↓	↑	↑	↓	20	Slight texture	Floating or glue	•	•	•
LifeProof Berkley Waterproof Engineered Bamboo Click YY-VSPC-DG02 (Home Depot) ²	52	\$3.70	↓	↓	↑	↑	↑	↑	↑	15	Slight texture	Floating	•	•	•
Harris Wood Traditions SpringLoc Red Oak Bridle HE2505OK48	43	\$5.50	↓	↓	↑	↓	↑	↑	↑	33	Slight texture	Floating or glue	•	•	•
Heritage Mill Scraped Oak Amaretto PF9773 (Home Depot)	43	\$4.30	↓	↓	↑	↓	↓	↑	↑	31	Slight texture	Nail, staple, glue or floating		•	•
Mannington American Hardwoods American Oak Plank Natural AMP05NAL1	42	\$4.00	↓	↓	↑	↓	↑	↑	↑	36	Smooth	Nail, staple, glue or floating	•	•	•
LAMINATE FLOORING															
Lumber Liquidators AquaSeal 24 Tapestry Oak 10047713	92	\$2.30	↑	↑	↑	↓	↑	↑	↑	16	Textured	Floating	•		
Pergo Outlast+ Vintage Pewter Oak LF000848 (Home Depot)	85	\$3.00	↑	↑	↑	↑	↑	↑	↑	20	Textured	Floating		•	
Lumber Liquidators Dream Home Boardwalk Oak 10043317	83	\$2.50	↑	↑	↑	↓	↑	↑	↑	15	Very Textured	Floating		•	•
Home Legend Textured Oak Paloma HL1226 (Home Depot)	80	\$2.50	↑	↑	↑	↓	↑	↑	↑	17	Very Textured	Floating	•	•	•
Pergo Portfolio+ Wet Protect Hermosa Oak LF000951 1071545 (Lowe's)	76	\$2.60	↑	↑	↑	↓	↑	↑	↑	17	Smooth	Floating with underlayment	•	•	•
Shaw Pinnacle Port Plus SL426 Weathered Hickory 05011	68	\$3.00	↑	↓	↑	↑	↑	↑	↑	19	Smooth	Floating	•	•	•
Pergo TimberCraft West Lake Oak LF000893 864889 (Lowe's)	65	\$3.00	↓	↓	↑	↓	↑	↑	↑	17	Very Textured	Floating	•	•	•
Armstrong Coastal Living L3051 White Wash Walnut	64	\$3.50	↓	↑	↑	↓	↑	↑	↑	14	Smooth	Floating	•	•	•
TrafficMaster Handscraped Saratoga Hickory 34089 (Home Depot)	53	\$1.10	↓	↓	↑	↓	↑	↑	↑	24	Slight texture	Floating	•	•	•
Armstrong Architectural Remnants Woodland Reclaim Old Original L3102	52	\$5.00	↓	↑	↑	↓	↑	↑	↑	22	Smooth	Floating	•	•	•
Home Decorators Collection Distressed Brown Hickory 34074SQ (Home Depot)	45	\$2.00	↓	↓	↑	↓	↑	↑	↑	15	Textured	Floating		•	•
Shaw Timberline SL247 Sawmill Hickory 255	44	\$5.00	↓	↓	↑	↓	↑	↑	↑	18	Slight texture	Floating		•	
Shaw Repel Harbour Towne SA589 Sable Hickory 07013	41	\$3.00	↓	↓	↑	↓	↑	↑	↑	19	Slight texture	Floating	•	•	•

> All-Access and Digital members can find the latest, complete ratings at [CR.org/flooring](https://www.consumerreports.org/flooring).

HOW WE TEST: **Overall Score** is based on performance in all of our tests. **Resists foot traffic** denotes how quickly surface wear was noticeable after repeated passes with an abrasion tester. **Resists scratches** indicates the ability to withstand scratches, as when an object with rough edges is dragged on a floor. A scratch tool is moved across the flooring sample with progressively heavier weight until a scratch is visible. **Resists stains** indicates how resistant the floor is to staining from various products, such as mustard, shoe polish, crayon, ink, bleach, and peroxide. **Resists dents** shows resistance to dents caused by blunt and pointed weights dropped from increasing heights. **Resists sunlight (UV)** indicates how well the flooring stood up to continuous exposure to ultraviolet light for roughly two weeks. **Price** per square foot is approximate retail.

Resources



From the Editors

2 Jo Galbraith, jogalbraithathome.com

Inspiring Updates

4-5 Will Taylor, brightbazaarblog.com

Weekend Makeovers

6-7 Left, Michael Fullen Design Group, michaelfullen.com.

Right, Morgan Harrison Home, morganharrisonhome.com.

8-9 Left, Storey Design, storeydesign.co;

Right, Sophie Burke Design, sophieburkedesign.com;

10-11 Left, Space10, space10.com;

Right, Brittany Hakimfar of Far Studio, farstudio.com

BUYING GUIDE

Opener

24-25 Jill O'Shea Home Design, jillosheahomedesign.com

Refrigerators

26 Quartersawn Design/Build, quartersawndesignbuild.com

28-29 Elena Phillips Interiors, elenaphillipsinteriors.com

Ranges

42-43 Kelly Deck Design, kellydeck.com

Cooktops

50 Tribe Design Group, tribedesigngroup.com

Wall Ovens

58 Bosch, bosch-home.com/us

Microwaves

62 GE, geappliances.com

64-65 Redirected Wood Company, redirectedwoodco.com

Dishwashers

70 Bosch, bosch-home.com/us

Cabinets

78 Ashley Marsella of 11-11 Creative, 11-11-creative.com

80-81 Studio H Design, studioh-int.com

81 Bottom left, KraftMaid, kraftmaid.com. Bottom right, Julie Deuble of Sierra Unlimited Construction, houzz.com/pro/jdeuble

82-83 Studio H Design, studioh-int.com

Countertops

84 Jill O'Shea Home Design, jillosheahomedesign.com

86 Bottom left, Kate Roos Design, kateroosdesign.com

88-89 Quartz: Cambria in Swanbridge, cambriausa.com.

Granite: Stonemark Granite

in White Ornamental, homedepot.com. Recycled glass: GEOS in Ocean Shell, eos-surfaces.com. Tile: Daltile in Hamilton Storm, homedepot.com. Ultracompact: Dekton Ultracompact in Aura15, dekton.com. Solid surfacing: Corian Solid Surfacing in Elderberry, corian.com

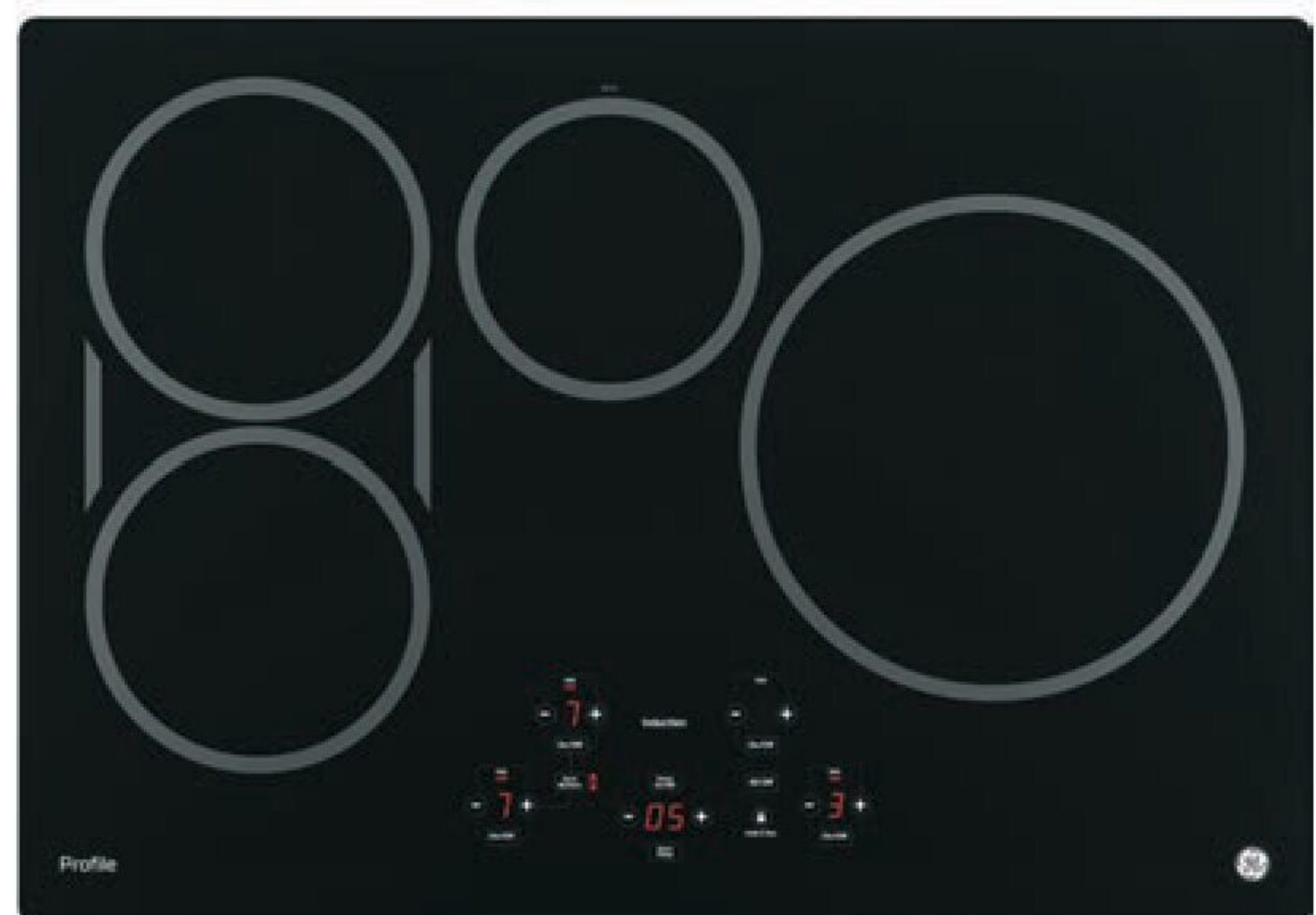

MEMBERSHIP BENEFIT



TESTING IS AT THE HEART OF CONSUMER REPORTS



You Test™ is your chance to get involved.

Test your knowledge, tell us your experiences with the products and services you already own and use, and give our experts real-world insights that help us research and test.

Check out You Test™ at [cr.org/mycr/benefits](https://www.consumerreports.org/mycr/benefits)

CR ConsumerReports®

Trusted Advice Delivered Straight to Your Inbox

Sign up for our FREE email newsletters.



From Money, Home, and Cars to Food, Health, and Shopping, CR's **FREE** email newsletters are packed with the information you need to shop smart and stay informed.

Go to

[cr.org/getnewsletters](https://www.consumerreports.org/getnewsletters)

to sign up today!

Money • Home • Cars • Shopping • Health • Food • What's New • Salud y Bienestar

CR Consumer Reports®